

# CamCon

PLC - Logic - Module

for DC16/51/90/115/300 and 1756-DICAM



## Digitronic Automationsanlagen GmbH

Steinbeisstraße 3 · D - 72636 Frickenhausen · Tel. (+49)7022/40590-0 · Fax -10  
Auf der Langwies 1 · D - 65510 Hünstetten-Wallbach · Tel. (+49)6126/9453-0 · Fax -42  
Internet: <http://www.digitronic.com> · E-Mail: [mail@digitronic.com](mailto:mail@digitronic.com)

**Please note:**

This handbook can only be used correctly in connection with the handbook of the digital cam controller CamCon. For a better understanding of the coherences it is very important that you read the complete manual. This manual corresponds to the software standard of the CamCon PLC Logic Module of 10/2003. The company Digitronic Automationsanlagen GmbH reserves the right to make changes which present an improvement of the quality or functionality of the device without prior notice. The instruction manual was created with great care, although it may not be error-proof. We would be grateful for any communication relating to any errors you may have found.

**UP-date**

You can also obtain this instruction manual on the Internet at <http://www.digitronic.com> in the latest version as PDF file.

**Qualified personnel**

This device may only be started and operated by qualified staff. By qualified we mean personnel who are entitled to handle, to earth and to lable devices, systems and power circuits in accordance with the technology safety standards.

**Liability**

(1) The supplier is liable for damages caused by himself or by the owner of the rights up to the sum of the sales price. He is not liable for loss of profits, forfeited savings, intermediate and successive damages.

(2) The above mentioned limits to liability do not apply to insurance of named characteristics and damages which were caused deliberately or through negligence.

**Protection**

The CamCon PLC - Logic - Modul and this instruction manual are protected by copyright. All rights are reserved. Neither the CamCon PLC - Logic - Modul, nor this document may be copied as a whole or partially, photocopied, reproduced, translated or transferred to electronic media of any kind or into machine readable format without prior written permission by the company Digitronic Automationsanlagen GmbH.

**Note:** We have examined the devices of the CamCon series for year 2000 compatibility and have not found any adverse effects on any functions.

**Note:** CamCon is a registered trademark of the company Firma Digitronic Automationsanlagen GmbH.

**Note:** The devices of the CamCon series comply with the standards for electromagnetic compatibility: EN 55011, EN 55022, EN 55024 Part 2, EN 50082 Part 2, ENV 50140, VDE 0843 Part 2, VDE 0843 Part 4, VDE 0871, VDE 0875 Part 3 ("N"), VDE 0875 Part 11, VDE 0877 Part 2, IEC 801 Part 3, IEC 801 Part 2, IEC 801 Part 4, IEC 801 Part 5.



(c) Copyright 1992 - 2004 / File: SPS\_E.DOC

Digitronic Automationsanlagen GmbH  
Auf der Langwies 1  
D-65510 Hünstetten - Wallbach  
Tel. (+49)6126/9453-0 Fax. (+49)6126/9453-42  
Internet: <http://www.digitronic.com>  
E-Mail: [mail@digitronic.com](mailto:mail@digitronic.com)

**Table of contents**

1. Introduction .....	5
1.1. Features .....	5
2. Principle of function.....	5
3. Configuration of the PLC.....	8
3.1. Access keys of the PLC Module .....	10
4. The structure of a logic network.....	10
5. Programming of the CanCon PLC Logic Module.....	11
5.1. The cursor.....	11
5.2. The standard logic.....	11
5.3. The selection of a logic network.....	12
5.4. Deletion of a logic network.....	13
5.5. Copying a logic network .....	13
5.6. Cross references.....	13
5.7. The logic path symbols .....	14
5.7.1. The conduction elements.....	14
5.7.2. Contact normally open .....	14
5.7.3. Contact normally closed.....	15
5.7.4. The output.....	15
5.8. The function component .....	16
5.8.1. The standard function component .....	16
5.8.2. The set - reset function component .....	16
5.8.3. The data flip - flop as a function component.....	17
5.8.4. The toggle flip - flop as a function component .....	17
5.8.5. Timer function components .....	18
5.8.5.1. The SI - timer as a function component.....	18
5.8.5.2. The SI - timer with negative edge control.....	18
5.8.5.3. The SV - timer as a function component .....	19
5.8.5.4. The SV - timer with negative edge control .....	19
5.8.5.5. The SE - timer as a function component .....	19
5.8.5.6. The SA - timer as a function component .....	20
5.8.5.6.1. Setting the time for the timer.....	20
5.8.6. Counter function component.....	21
5.8.6.1. The forwards counter as a function component.....	21
5.8.6.2. The forwards counter with negative edge control .....	21
5.8.6.3. The backwards counter as a function component .....	22
5.8.6.4. The backwards counter with the negative edge control .....	22
5.8.6.4.1. Input of the counter value.....	22
5.8.6.4.1.1. Manual reset of a counter .....	22
5.8.6.4.2. Input of a second counter condition .....	23
5.8.6.4.3. . Input of the counter reset requirement.....	23
5.8.7. The synchronous shift register .....	24
5.8.7.1. The parameters of the angle-synchronous shift register .....	25
6. Display of the in- and output states.....	26

7. The text display of the PLC module .....	27
7.1. Programming of a message.....	27
7.2. Text input .....	28
7.3. The display of the message .....	29
7.4. Acknowledging the message .....	29
7.4.1. Supressing messages for 30 seconds.....	29
8. Outline of the key functions.....	30
9. Examples for using the PLC Logic Module .....	31
9.1. Output deactivation .....	31
9.2. Output dependent on the rotation direction.....	31
9.3. Output with a seperate speed compensation for activation and deactivation point .....	31
9.4. Edge evaluation .....	32
9.5. Toggle function or power surge function.....	32
9.6. Simple shift register function.....	32
9.7. Example of an angle-synchronous shift register .....	33
10. User menu or OP function .....	34
10.1. Entering a menu page.....	34
10.1.1. Selecting a user menu for definition.....	34
10.1.2. Defining the menu page.....	35
10.1.2.1. Menu line 1 or heading.....	35
10.1.2.2. Menu lines 2 - 7 or variable access.....	35
10.1.2.3. Variable types.....	36
10.1.2.3.1. Parameters of the CAM variables .....	36
10.1.2.3.2. Parameters of the PLC ACTUAL/NOW variable.....	37
10.1.2.3.3. Parameters of the PLC PRESET variables.....	37
10.1.2.3.4. Parameters of the DELAY TIME variables.....	38
10.1.2.3.5. Parameters of the bit V-input variables .....	38
10.1.2.3.6. Parameters of the D-TAB variables .....	39
10.1.2.3.7. Parameters of the D-TAB-PRESET-variables .....	39
10.1.3. Deleting a user menu.....	40
10.2. Selection, variable entry and displaying the user menu in the standard display .....	40
10.2.1. Error message during entry.....	40
11. RAM memory in the PLC Logic Module .....	41
12. EEPROM memory in the PLC Logic Module .....	41
13. Technical data of the CamCon PLC Logic Module .....	41
14. Programing of the PLC-Logic-Module on DC300 or 1756-DICAM .....	42
15. Structure of a logic network in the memory.....	43
15.1. Structure of the output field (function component).....	43
15.2. Structure of the input cells.....	44
16. Key word table.....	46

## 1. Introduction

The firm Digitronic Automationsanlagen GmbH is known to have been successful in the industry for a long time as a supplier and developer of electronic cam switching devices. The experiences that were gained in these years, in close co-operation with the users of Digitronic products, of connecting PLC controls and cam switching devices have been considered in the development of the CamCon PLC Logic Module. The result is a PLC software that, in the CamCon, operates parallel to the cam switch unit. The inputs and outputs of the cam switch unit are linked without external logic and without necessary hardware, e.g. latches, timers (way - time - cams), set - reset - function, or registers, and are thus processed in the same cycle time as the cam switch unit. This combination ensures the best possibility for efficient use of the speed compensation of the cam switch unit and the logic of the PLC, without the loss of switching speed through external and slower switching elements (e.g. relays, time units, central PLC controls with high cycle time).

**Attention:** Because the software was upgraded with the new counter function, you need DIGISOFT software version 1.20 or higher for data storage on your PC.

### 1.1. Features

The following features distinguish the CamCon PLC Logic Module:

- \* No additional hardware is necessary because of full integration of the software.
- \* Short and constant cycle time through special software algorithms.
- \* Time cams.
- \* Display of the functions in the contact plan.
- \* Special functions like e.g. the set - reset - function, data flip - flop, 6 different timer functions, 4 different counter functions and up to 200 shift registers with Speed Compensation.
- \* remanent counter.
- \* OP function.
- \* Integrated fault message display.
- \* No programming device is necessary.

## 2. Principle of function

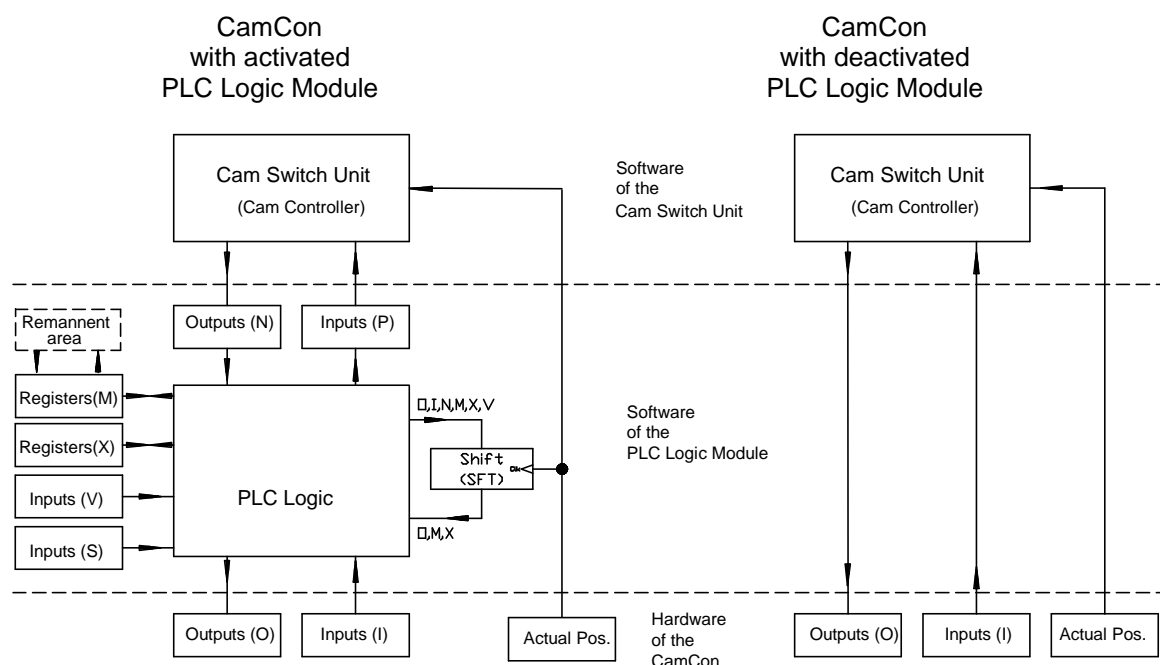

The CamCon with the PLC Logic Module connects the external hardware in- and outputs with the internal software of the cam switch unit. This connection is implemented through virtual inputs and outputs on the PLC Logic Module. Because of this technology, it is possible to change and control all activities of the cam switch unit with the PLC Logic Module.

This divides the in- and outputs of the PLC Logic Module into the following 8 ranges :

- 1. Physical Inputs are abbreviated with an **I**. They correspond with the Inputs at the connection pins.
- 2. Physical Outputs are abbreviated with an **O**. They correspond with the Outputs at the connection pins.
- 3. The connection from the PLC Logic Module to the inputs of the cam switch unit' s software is implemented through PLC outputs labeled **P**. These outputs of the PLC act as inputs **P** in the cam switch unit and effect the input functions like e.g. the program selection, the position preset and the keyboard lock, as well as the controller inputs of the measuring system (e.g. halt and clear).
- 4. The connection from the outputs of the cam switch unit' s software to the inputs of the PLC Logic Module is realized through PLC inputs labeled **N**. In the PLC logic, the outputs of the cam switch unit function as inputs and can be switched to the hardware outputs **O** by dis- or enabling them. Of course outputs of the cam switch unit with speed compensation are transferred to the PLC with all functions.
- 5. The registers only available in the PLC Logic Module. They are abbreviated with the symbol **M** and function as outputs, although they are not connected. Additionally, this space can be made remanent or secured against power loss by activating the "REM" Option . You can choose between the two memory types "High Speed" and "Standard". With the "Standard" version, the remanency data is stored every 60 minutes in normal EE - Prom memory. If you ordered the "High Speed" version (Option: HSR), the data is stored every minute in an additional IC of the unit.
- 6. The registers only available in the PLC Logic Module. They are abbreviated with the symbol **X** and function as outputs, although they are not connected.
- 7. The virtual inputs. They are used for communication with external controls (as, for example the S5, S7 or ControlLogix) and act as regular inputs, although beeing controlled by a rear-panel-BUS. They are abbreviated with the symbol **V**. With a CamCon DC300 these inputs are controlled via the S7 periphery Bytes 0-7 (PAB), with a CamCon 1756-Dicam via "Local:X:O.Data"-zone. They are used e.g. to block or allocate outputs.  
This option is also available, if you are using a CamCon DC16/40/50/51 or DC90 with the S5-L1 interface.and can also be accessed by an external controller via the serial interface of the CamCon (e.g. PC).
- 8. The special inputs. These inputs are abbreviated with the symbol **S**. There are currently 6 input functions available.
  - S-Input 1: During the moment of activation (first scan), this input emmits a short impulse, that can be used to reset the stored registers and counters, since these are in an undefined state after activation.
  - S-Input 2: Shows position error 1, 2 or 3.
  - S-Input 3: Shows an output error.
  - S-Input 4: Shows actual position error 5.
  - S-Input 5: Shows that the connection to the CP16 bus module was correctly established. If the CP16 makes inputs available for the CamCon, you may only allocated those inputs in the PLC, after this input has been activated.

S-Input 6: Shows with DC300 and 1756-DICAM the condition of the PLC CPU (ON=RUN).

S-Inputs 9-24: Shows current program number.

S-Inputs 25-32: Shows the number of the current message of the Integrated fault message display.

S-Inputs 33-64: Shows which key on the keyboard of the DC51 are pressed.

with DC40 S - Input Key

37 F

38 N

39 +

40 -

with DC51 S- Input Key

34 0

35 5

37 CR

38 BS

39 #

40 ESC

42 2

43 7

44 cam ON symbol

46 DEL

47 INS

48 CU\_UP

50 3

51 8

52 CU\_LEFT

54 .

55 -

56 CU\_RIGTH

58 4

59 9

60 CU\_DOWN

62 1

63 6

64 cam OFF symbol

S-Inputs 65-96: Here the current actual value of the CamCon is indicated, if the real time actual value output is adjusted to binary.

See menu "System configuration", sub menu "special outputs", the "Real time actual value output".

### 3. Configuration of the PLC



From the main menu of the CamCon you get to the "configuration menu" by selecting the menu point "Unit configuration". At first, you will have to configure the hardware. Select the menu "Configure Hardware" and enter the number of physical in- and outputs of your device. These numbers have to correspond with the actual number of in- and outputs, other numbers can result in errors in operation. Your entry of the in- and outputs in the cam controller software in the menu point "System upgrading" of the "System setting" menu, may differ from the number of physical in- and outputs in connection with an activated PLC Logic Module. This makes it possible to e.g. assign 16 outputs to the cam controller and 32 physical outputs to the PLC Logic Module, as a result, that the last 16 outputs can only be accessed by the PLC. Additionally, a CP16 Bus Module connected to the CamCon is configured in this menu.

```
Configure Hardware
Phys.input: 16
Phys.outp.: 32
CP-type :No busmodul
```

Exit the menu by pressing the ESC key and select the menu point "PLC configuration". The following menu will appear:

```
PLC configuration
PLC-module: off

PLC configuration
PLC-module: on
MRegisters: 0
XRegisters: 0
Timer/Cnt.: 0 ( 0)
Virt. inp.: 0
Spec. inp.: 96
Shift: 8* 2160( 2)
```

The PLC Logic Module can be generally (de)activated in the first menu point, using keys  or . You can choose between 3 functions: "off", "on" or "on /Rem".

- "off": The PLC Logic Module is deactivated. This is a good choice, if you do not need the PLC Logic Module for your operation, since resulting in a reduction of cycle time.
- "on": The PLC Logic Module is activated.
- "on /Rem": The PLC Logic Module is activated and the registers **M** are stored power loss proof or remanent. With this option, you have to specify "Standard" or "High-Speed". In the "Standard" mode, the remanency data is stored every 60 minutes in normal EE - Prom memory. If you ordered the "High Speed" version (Option: HSR), the data is stored every minute in an additional IC of the unit



After the activation of the PLC Logic Module, you can configure the number of registers, counters and timers you wish to use. All entries are rounded up to full steps of 8 by the CamCon.

**M-Registers:** 0..248, number of registers in the M - area.

**X-Registers:** 0..248, number of registers in the X - area.

**Timer/Cnt.:** 0..200, maximum number of timers - and/or counter components for use.  
The number of the Timer/Cnt. setting are divided into timers and counters. However, for a counter with reset input you need 2 components. 8 counters with reset input will need a Timer/Cnt. value of 16. The number of the currently programmed/used timers or counters is shown in the brackets.

**V-Inputs:** 0..200, number of inputs in the V - area.

**S-Inputs:** 0..96, number of inputs in the S - area.

**Shift:** 0..200, number of shift registers in the PLC - logic - module for use. The number of the currently used shift registers is shown in the brackets

**\*:** 256..999999, maximum number of sliding cells in the shift register. To specify this value, please first see chapter "5.8.7. The synchronous shift register" on page 24. Since the shift register is clocked synchronously for the actual value of the CamCon, the input of this value is executed in the same unit as the actual value announcement (e.g. degree or mm).

**Note:** The input is always rounded up by the CamCon to a multiple of the resolution of the measuring system.

**Note:** You should only enter the absolutely necessary value, because every register, counter and timer increases the cycle time.

**Note:** If the required memory of the PLC Module exceeds the remaining memory of the CamCon (see chapter 11. RAM memory in the PLC Logic Module on page 41 ), the PLC Module is deactivated and an error message is displayed.

### 3.1. Access keys of the PLC Module

To give the user the ability to prevent the programming by unauthorized persons after the PLC Module has been activated, you can now select the access to the PLC programming in the "Key allocation" menu.

### 4. The structure of a logic network

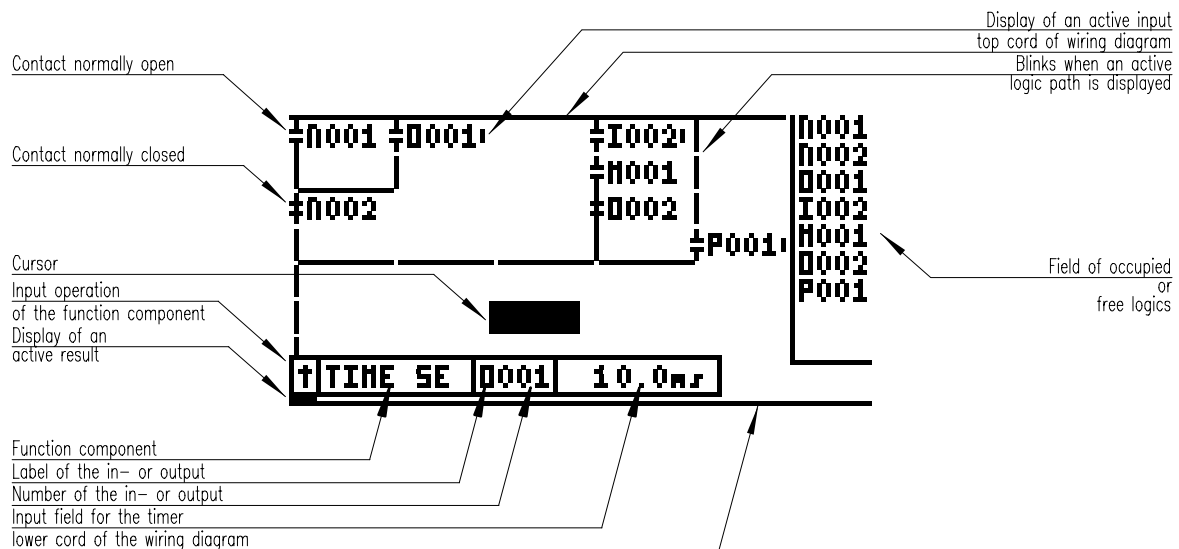

The CanCon sets up a logic network for every output (O,M, X and P-area) of the PLC, that has the size of the whole screen. This network is programmed in the contact logic diagram mode and is limited to one page of the display screen. The figure above is an example for a network with several inputs on the hardware output **O001** with a positive edge-triggered signal activation delay of 10.0ms.

In the upper part of the screen there is always the cord of the supply voltage **L+**. If the cursor stands at the desired point in the wiring diagram, a logic path symbol is connected by pressing certain keys. In the lower part of the screen you can always find the cord of the supply voltage **L-**, to which a function component is always connected (e.g. timer).

The logic field is displayed in the right area of the display screen. The structure of the CanCon PLC Logic Module is based upon a matrix. On the one hand this matrix enables a low cycle time, on the other hand it needs a lot of memory. In order not to overshoot the memory of the CamCon, the number of logic inputs is limited to 9/2 (9 inputs at 2 outputs). In the logic field you can see the in- and outputs you have already used in your network. There are additional in- or output options at your disposal, if the field is not filled to the bottom. If the logic field is fully occupied, you can only insert those inputs that are already present in the logic, other input options are not allowed by the software.

## 5. Programming of the CanCon PLC Logic Module

To reach the programming of the PLC Logic Module, select the menu point "PLC" in the main menu of the CamCon . Enter the access code to the PLC menu at the key code request and the logic network of the hardware output 1 appears on the display.

**Annotation:** For informations about programming the PLC-Logic-Module via a PLC (e.g. Siemens S7-300 or Rockwell ControlLogix 1756 see chapter "14. Programing of the PLC-Logic-Module on DC300 or 1756-DICAM" on page 42

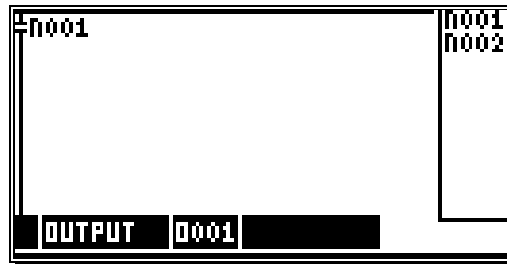





Now you can begin with the programming.

Note the change of the logic happens beeing On - Line. The changed logic is performed immediatly.



To leave the PLC Logic Module, press the  key twice.

### 5.1. The cursor

With the help of the keys     you can move the cursor to the positions, at which you want to make changes or inputs. The position of the cursor is always highlighted by the inverse display of the symbol of the cursor' s current position.

If the cursor is at the left margin of the display screen, a pressing of the  key leads to the processing of the network that stands in the memory in front of the current network.

If the cursor is at the right margin of the screen, a pressing of the  key leads to the processing of the network that comes after the current network in the memory.

The same happens, if the cursor is in the range of the function module, recognizable by the inverse display of the function module, and when the  key or the  key is pressed.

### 5.2. The standard logic

After you have performed a complete deletion of the CamCon , or after activating the device for the first time, in the logic networks the inputs **P** are linked to the hardware inputs **I**, and the hardware outputs **O** are linked to the outputs **N** of the cam switch unit. If a logic network is deleted by pressing the  key (see chapter 5.4. Deletion of a logic network on page 13), this standard logic becomes the basic setting.

### 5.3. The selection of a logic network

There are several methods for the selection of a certain logic network:

**1. By continuing to switch with the cursor.**

( see chapter 5.1. The cursor on page 11 ).

**2. By directly entering the output type and the corresponding output number.**

The cursor has to be in the range of the function component, recognizable by the inverse display of the function component.



The process of the direct input is initiated by pressing the **CR** key.

You can either enter the number of the desired logic network with the numeric keys, or you can switch through the output types, using the keys **↵** and **↶**, and enter the number of the logic network with the numeric keys afterwards.

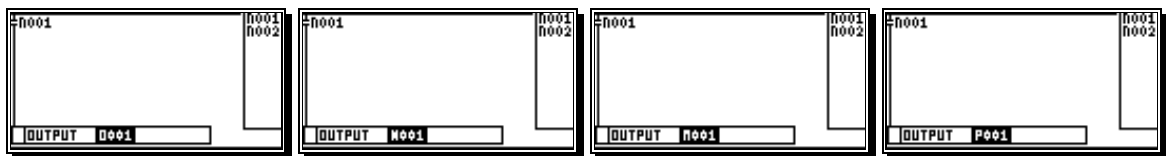

After pressing the **CR** key the entered logic network is selected and the logic is displayed on the screen.

**3. By selecting the output type with the help of the keys **↵** and **↶**.**

The cursor has to be in the range of the function component, recognizable by the inverse display of the function component.

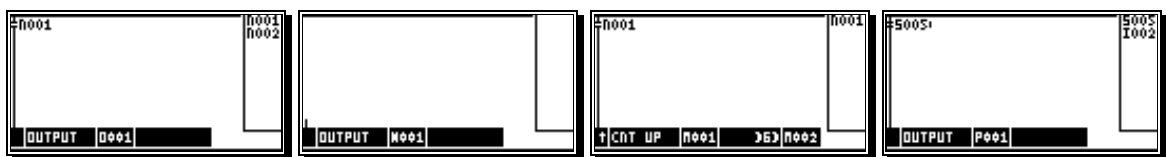

The selection of the logic network is processed directly after you have pressed either the **↵** key or the **↶** key. When you have selected the desired network, you can start programming the logic or make the changes you wish.

### 5.4. Deletion of a logic network

To delete a logic network you have to select the network that is to be erased (see chapter 5.3. The selection of a logic network on page 12), and by pressing the **DEL** key, the network is completely deleted. The output types **O** and **P** are directly set to standard logic.

**Attention !!:** The deleted network can only be restored by immediately pressing the **INS** key. Once another key is pressed, the deleted network cannot be restored !

### 5.5. Copying a logic network

To copy a logic network, you have to select the network you want to copy (see chapter 5.3. The selection of a logic network on page 12). By pressing the **.** key the network is copied into the intermediate memory. You can leave the possibly open cross reference list by pressing the **ESC** key. Now target the linkage network and insert the clipboard by pressing the **INS** key.

**Attention !!:** If the **INS** key is pressed again, the previously overwritten logic network is restored.

### 5.6. Cross references

If you want to get a comment about the cross references of a contact or a register/output, use the keys **▼ ▲ ◀ ▶** to move the cursor to the linked element for which you want to view the cross reference list and press the **.** key.

<pre> n017 n019 n018 M001 OUTPUT O001         </pre>	+ . =	<pre> Querverweis für: O001         </pre>	<p>Here output O001 is currently not used in a linked network.</p>
<pre> n017 n019 n018 M001 OUTPUT O001         </pre>	+ . =	<pre> Querverweis für: M001 O001 O002 M002         </pre>	<p>The register M001 is currently used in networks O001, O002 and M002.</p>

In the cross reference list, you can know choose a linked network with

the keys **▼ ▲ ◀ ▶**, and select it by pressing the **CR** key.

<pre> Querverweis für: M001 O001 O002 M002         </pre>	+ CR =	<pre> M001 OUTPUT M002         </pre>
---	--------	---------------------------------------

If you want to cancel, please press the **ESC** key to return to the old linked network.

## 5.7. The logic path symbols

To construct a logic diagram you can use 7 different logic path symbols. By pressing the **[0]** key, the logic path symbol at the current position of the cursor is deleted.

### 5.7.1. The conduction elements

By pressing the **[1]** key, you insert vertical conduction elements at the current cursor position.  
By pressing the **[5]** key, you can insert horizontal conduction elements at the current cursor position.

A conduction consisting of vertical and horizontal elements is inserted at the current position of the cursor when the **[6]** key is pressed.

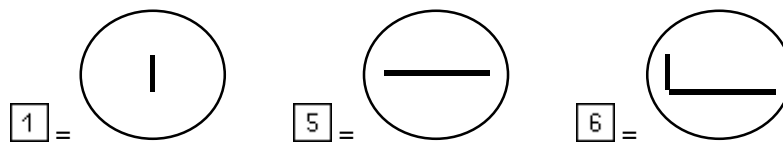

### 5.7.2. Contact normally open

In the logic, normally open contacts are always displayed in the manner shown in the figure below and are inserted at the current position of the cursor by pressing the **[2]** key. The symbol for an currently closed contact is displayed to the right of the contact's label, as a small vertical bar.

Contacts normally open connected to horizontal conduction elements are inserted at the current position of the cursor with the help of the **[7]** key.

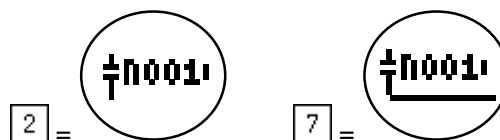

If the cursor is situated on the symbol of the normally open contact and the **[CR]** key is pressed, the input of the input type and the input number is initiated. You can set the number of the input with the keys **[0]** to **[9]** and the input type (**O,I,N,P,X,M,V,S**) with the keys **[J]** and **[L]**. This data input is confirmed by pressing the **[CR]** key.

### 5.7.3. Contact normally closed

In the logic, normally closed contacts are always displayed in the manner shown in the figure below and are inserted at the current position of the cursor by pressing the 3 key. The symbol for an currently open contact is displayed to the right of the contact' s label, as a small vertical bar. Contacts normally closed with connected horizontal conduction elements are inserted at the current position of the cursor with the help of the 8 key.

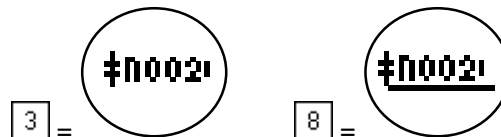

If the cursor is situated on the symbol of the normally closed contact and the CR key is pressed, the input of the input type and the input number is initiated. You can set the number of the input with keys 0 through 9 and the input type (**O,I,N,P,X,M,V,S**) with the keys J and L. This data input is confirmed by pressing the CR key.

### 5.7.4. The output

The outputs of the PLC in connection with the function component have the ability to create different special logic functions. A logic network is assigned to every output, in which a certain number of inputs (up to 9) may be linked. There are 3 different output types available, labeled **O** (Output), **P** (cam controller input) and **M** (registers) (see chapter 2. Principle of function on page 5), that are set using the keys J and L. For this purpose the cursor has to be within the range of the function component. An output without a special function component is displayed as in the drawing below.

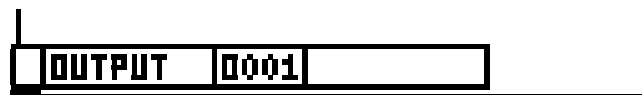

If a change of the output number is desired, press the CR key to call a direct input of the output number. For this purpose the cursor has to be situated within the range of the function component

### 5.8. The function component

Function components are used in the PLC as a special control of the outputs. Delays or flip - flops are possible and can thus contribute to the simplification of the logic. There are basically 15 different function components. If the cursor is within the range of the function component, recognizable by the inverse display of the function component, you can choose the function component type with the keys **0** through **9** at the edge-characteristics can be selected by pressing **±**.

#### 5.8.1. The standard function component

The standard - output is selected by pressing the **0** key.

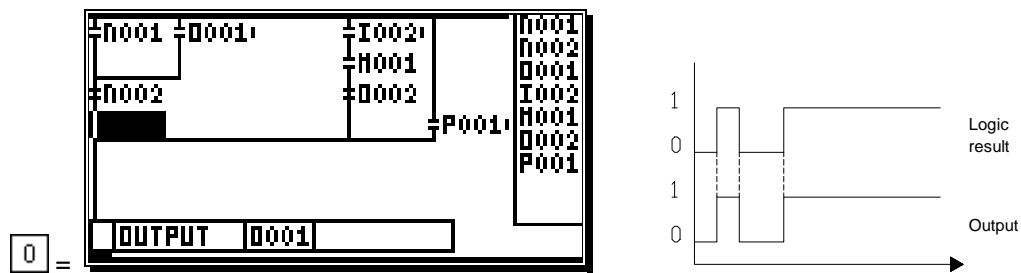

Here the logic result is switched to the output without special functions.

#### 5.8.2. The set - reset function component

The set - reset function is selected by pressing the **1** key.

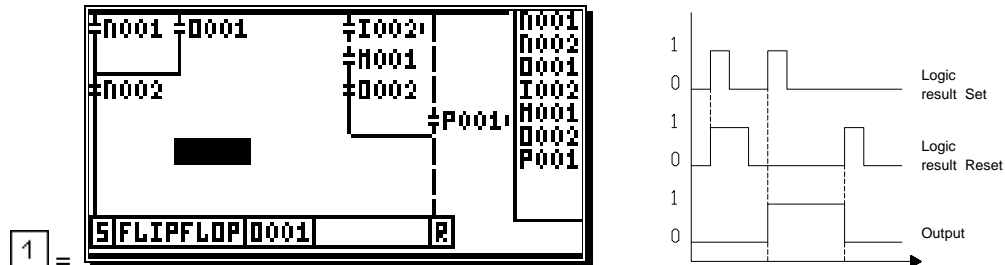

If the logic result becomes true at the set input, the output is activated. It remains active until the reset input receives a signal. Now the output is turned off again. If both signals are present at once, the reset input has a greater priority than the set input.



### 5.8.3. The data flip - flop as a function component

The data flip - flop is selected by pressing the 2 key.

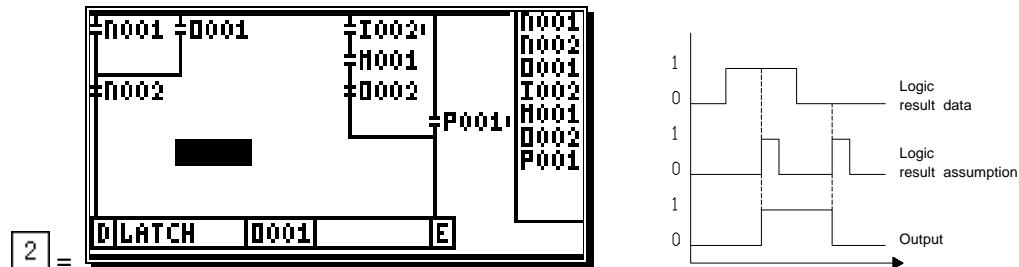

The state of the logic at the data input of the flip - flop is adopted, as long as there is a signal at the strope input. If the strope input is reset, the last signal at the data input is stored in the output.

### 5.8.4. The toggle flip - flop as a function component

The toggle flip - flop is selected by pressing the 3 key.

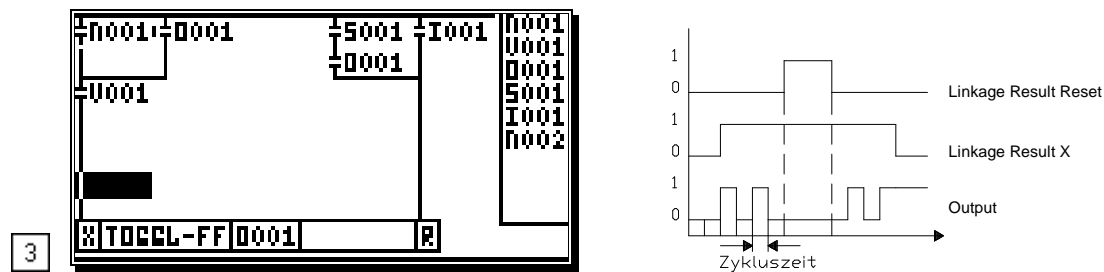

If the logic result at the input is true, the state of the output signal is switched at every cycle of the PLC. When the input signal is reset, the output is stored in its current state. By setting up a signal at the Reset-Input the output will be deactivated. If both signals appear at the same time, the reset-Input is of greater priority.

### 5.8.5. Timer function components

Structure of a timer function component:

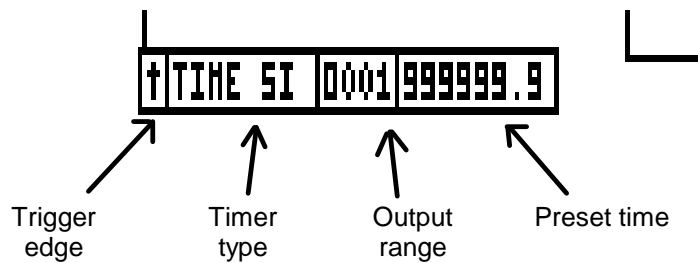

There are 6 different timers available in the PLC Logic Module:

**Annotation:** The timer is only available if the variable "Timer/Cnt." is adjusted above 0 and enough timers are not yet set. See also chapter "3. Configuration of the PLC" on page 8.

#### 5.8.5.1. The SI - timer as a function component

The SI - timer function with positive edge control is selected by pressing the key 4.

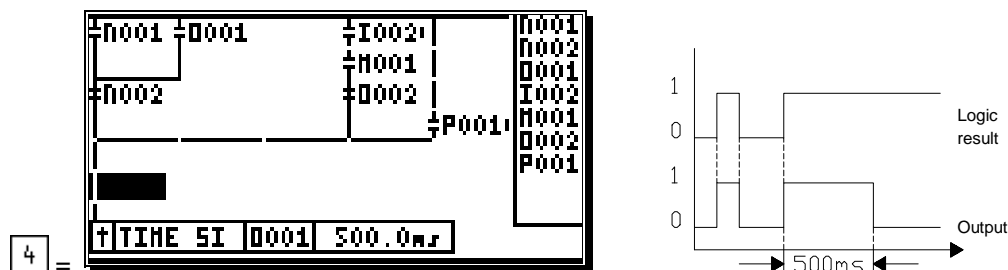

The activation-edge of the logic-result triggers an impulse that does not overshoot a maximum time of 500ms. The impulse is interrupted if the logic result becomes false and the time has not run out.

#### 5.8.5.2. The SI - timer with negative edge control

The SI - timer function with negative edge control is selected by pressing the 4 key followed by pressing ±

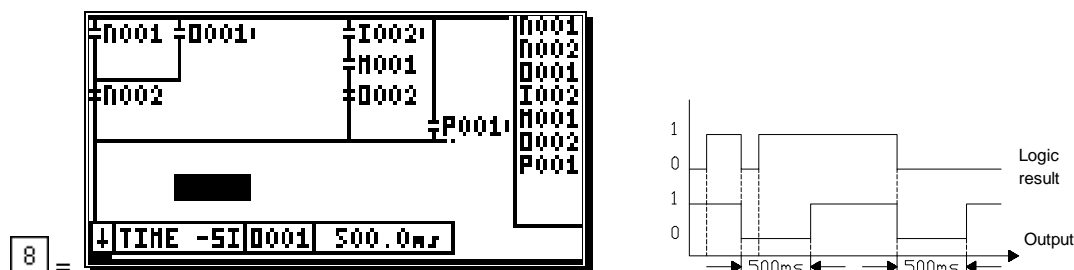

The output is reset with the deactivation edge of the logic result for 500ms. After this time the output is set up to the next deactivation edge.

### 5.8.5.3. The SV - timer as a function component

The SV - Timer function with positive edge control is selected by pressing the **5** key.

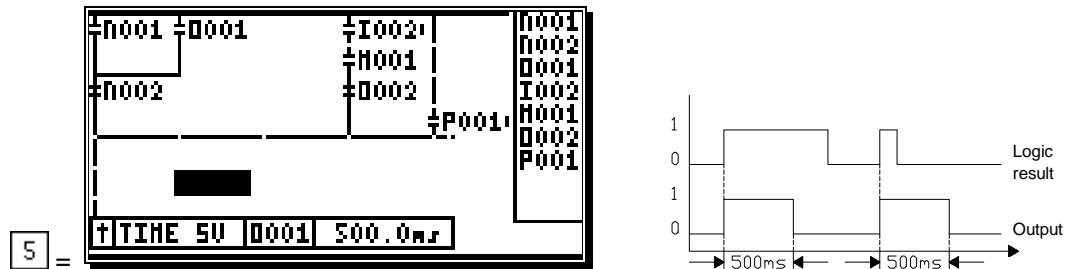

The activation edge of the logic result triggers an impulse that has the length of exactly 500ms. The impulse cannot be interrupted, but can be extended through repeated, successive triggering.

### 5.8.5.4. The SV - timer with negative edge control

The SV - timer function with negative edge control is selected with the **9** and then the **±** key.

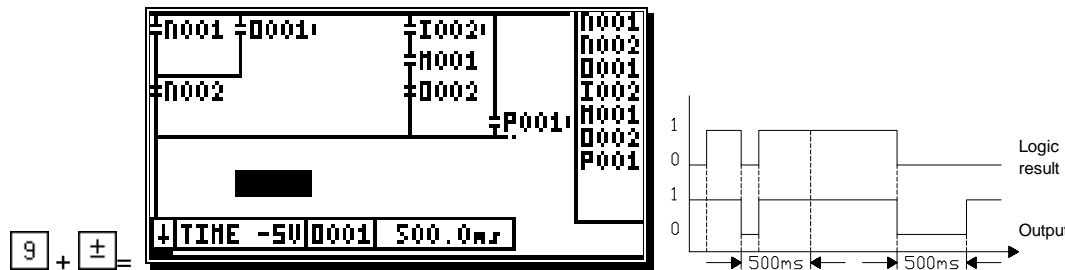

The output is reset with the deactivation edge of the logic result for a maximum of 500ms. The output is instantly activated, if the logic result becomes true again, before the set time is up.

### 5.8.5.5. The SE - timer as a function component

The SE - timer function with positive edge control is selected by pressing the key **6**.

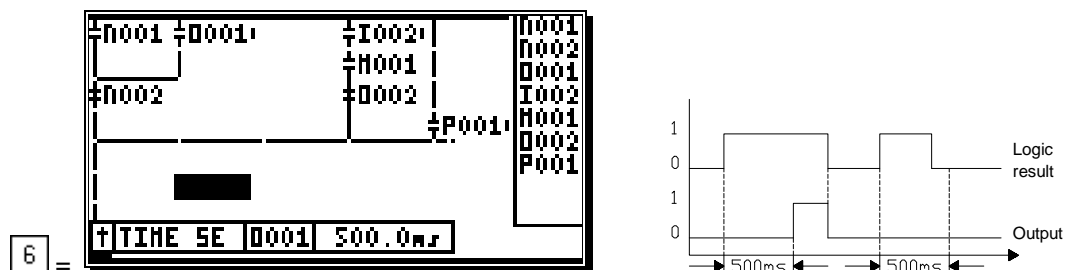

The activation edge of the logic result triggers a time that activates the output after exactly 500ms. The output is deactivated, if the logic result becomes false or it is not activated, if the logic-result becomes false before the 500ms have passed.

### 5.8.5.6. The SA - timer as a function component

The SA - timer function with negative edge-control is selected by pressing the  $\boxed{6}$  and then the  $\boxed{\pm}$  key.

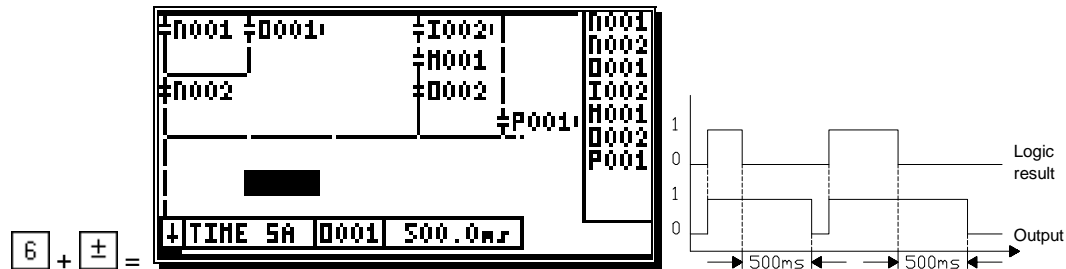

The output is set with the activation edge of the logic result and the deactivation edge triggers a time that resets the output after 500ms.

#### 5.8.5.6.1. Setting the time for the timer

For the input of time values with the timer-functions, the cursor has to be within the range of the function component. The input of the time is initiated by pressing the  $\boxed{\#}$  key.

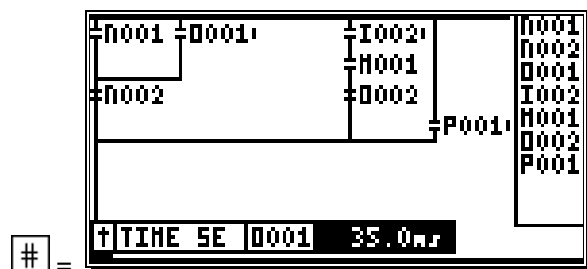

After the input of the time, which can be in the range of 0.0..6551.9ms, you confirm the new value with the  $\boxed{CR}$  key.

### 5.8.6. Counter function component

Structure of the counter function component:

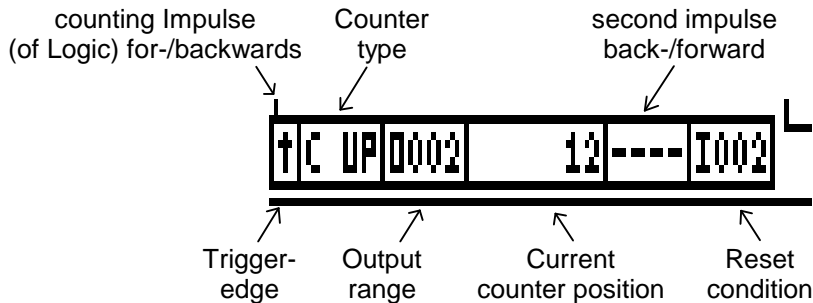

There are 4 different counter types available in the PLC Logic Module. Every counter has one for- and one backwards counting impulse, as well as a Reset-signal. Depending on the chosen Counter-type both impulses effect counting for- or backwards on the counter's display.

**Note:** The timer is only available if the variable "Timer/Cnt." is adjusted above 0 and enough timers are not yet set. See also chapter "3. Configuration of the PLC" on page 8.

**Note:** Counters in the M - Register Range can be stored power loss proof / remanent. See chapter "3. Configuration of the PLC" on page 8.

#### 5.8.6.1. The forwards counter as a function component

The forwards counter with positive edge control is selected by pressing the  $\boxed{7}$  key.

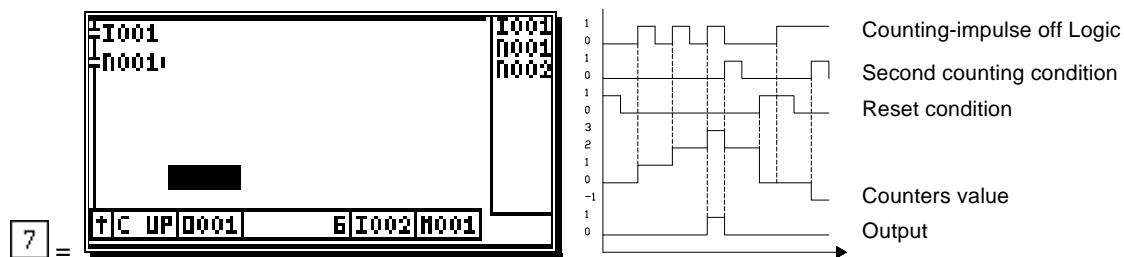

The counter is increased by one with the positive activation edge of the linkage result "I001+N001". If this causes the counter-value to reach its set accumulated value (in this example 3), the output is activated. A positive edge of the second counting condition "I002" becomes true, the counter value is reduced by 1. If the reset-condition "M001" is met, the counter is set to "0", and the output is reset.

#### 5.8.6.2. The forwards counter with negative edge control

The forwards counter with negative edge control is selected by first pressing the  $\boxed{7}$  and then the  $\boxed{\pm}$  key.

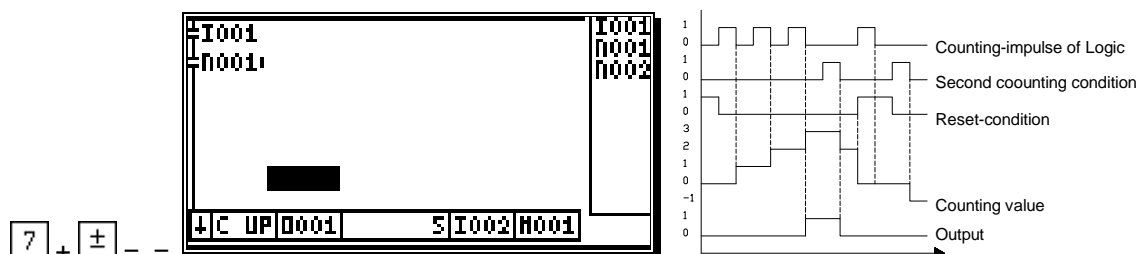

The counter is increased by one with the negative deactivation edge of the linkage result "I001+N001". If this causes the counter-value to reach its set accumulated value (in this example 3), the output is activated. A negative edge of the second counting condition "I002" becomes true, the counter value is reduced by 1. If the reset-condition "M001" is met, the counter is set to "0", and the output is reset.

### 5.8.6.3. The backwards counter as a function component

The backwards counter with positive edge control is selected by pressing the key  $\boxed{8}$ .

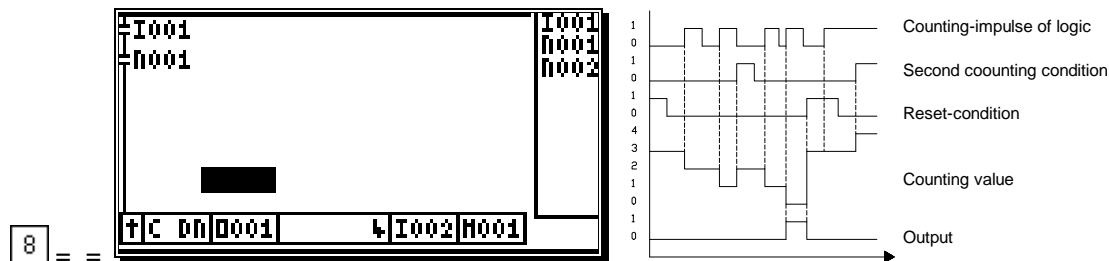

The counter is decreased by one with the positive edge of the linkage result "I001+N001". If this causes the counter value to reach "0", the output is activated. With a positive edge of the second counting condition "I002" the counter's value is increased by 1. If the reset condition "M001" becomes true, the counter value is set to its starting value (in this case 3), and the output is reset.

### 5.8.6.4. The backwards counter with the negative edge control

The backwards counter with negative edge control is selected by first pressing the  $\boxed{8}$  and then the  $\boxed{\pm}$  key.

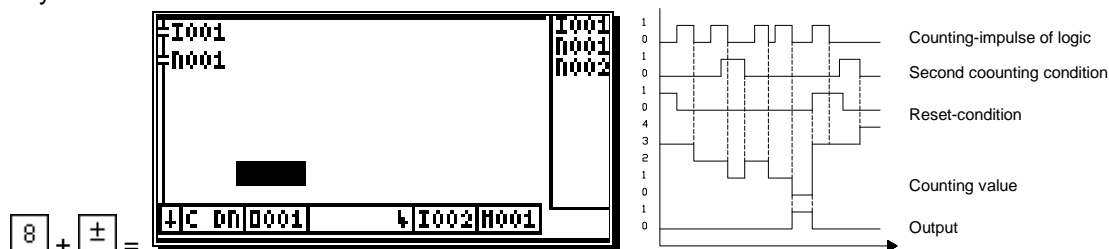

The counter is decreased by one with the negative edge of the linkage result "I001+N001". If this causes the counter value to reach "0", the output is activated. A negative edge of the second counting condition "I002" increases the counter's value by 1. If the reset condition "M001" becomes true, the counter value is set to its starting value (in this case 3), and the output is reset.

#### 5.8.6.4.1. Input of the counter value

For the input of the counter values into the counter function components, the cursor has to be in the range of the function component. The input of the counter value is initiated through the pressing of the  $\boxed{\#}$  key.



After the input of the counter value, that can be within the range of 0 to 9999999, the value is confirmed by pressing the  $\boxed{CR}$  key. After that you enter the input of the counter reset requirement.

#### 5.8.6.4.1.1. Manual reset of a counter

If pressing the key  $\boxed{DEL}$  while entering a counter value before having confirmed with key  $\boxed{CR}$ , the counter is reset.

#### 5.8.6.4.2. Input of a second counter condition

New: The second counting condition is only available for software-version 10/2003 or later.

After entering the counting- or set-value (see chapter above) you are now able to input a condition, that increases (or reduces) the counter's value referring to the counter-type. This second condition can be triggered by every single one of the In-Outputs (**O,I,N,P,X,M,V,S**).

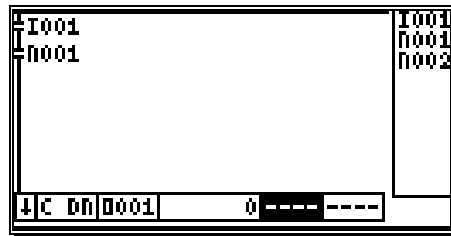

At first you will have to select the In-Output-section by pressing the keys  $\uparrow$  or  $\downarrow$ . Use the keys  $\square$  to  $\square$  to input the number. Confirm your inputs by pressing  $\square$  and move on to reset conditions.

**Annotation:** This Signal enables setting the counter's value below 0 (forward Z) and above the starting value (backward Z). Reaching the counter's final value (output active) an corresponding edge at this signal immediatly quits the final value.

#### 5.8.6.4.3. . Input of the counter reset requirement

After you entered the counter value for the counter function component, you can set the reset requirement of the counter in this field. The counter reset can be triggered by any of the 7 in- output ranges (**O,I,N,P,X,M,V,S**).

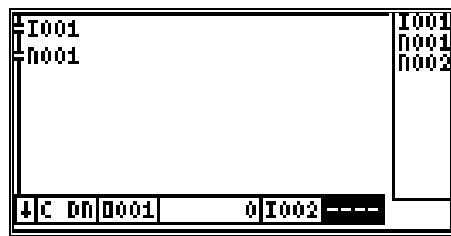

For a correct input you have to enter the desired in- output range with the  $\uparrow$  and the  $\downarrow$  key and set the input number with keys  $\square$  through  $\square$ . Pressing the  $\square$  key confirms the value and exits the input.

**Example:**



Here the input "I002" is used as a second counting condition meanwhile the marker "M001" is used as a reset-condition.

By triggering the reset requirement, the counter is set to its starting value and a set output is reset. An edge that is adjusted corresponding to the counter's type at the second counting condition "I002" reduces the forward counter by 1 as well as increasing the backward counter by 1

### 5.8.7. The synchronous shift register

The function of the synchronous shift register is explained best via an example:

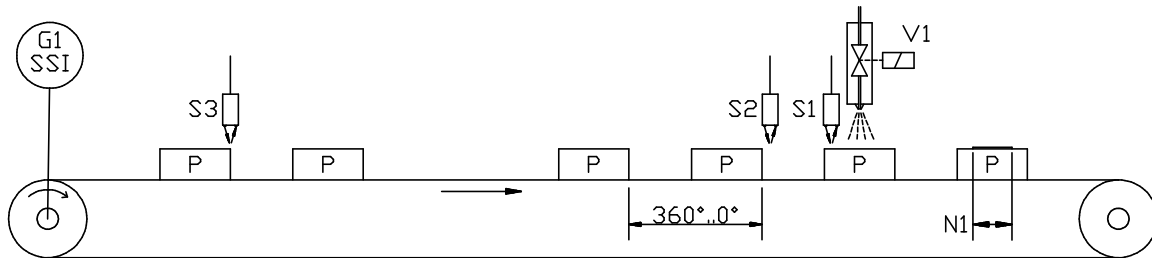

#### Problem:

On a conveyor belt product (P) is to be coated with adhesive at an adhesive station (V1). The adhesive station (V1) may only be triggered when a product (P) is present.

#### Solution 1 with light barrier S1:

If the plant operates at a fixed speed, a light barrier (S1) can recognise the product (P) and cam (N1) can easily trigger the adhesion process via a time relay.

#### Solution 2 with light barrier S2:

If the plant operates at a flexible speed, the adhesion triggering process must be triggered by an electronic cam switching mechanism with speed compensation, so that the delay of the adhesive station (V1) can be compensated for in relation to the respective speed. One way of determining the position of the product (P) is to use an SSI angle-position encoder with a resolution of 360 degrees (G1). However, for this solution the light barrier position (S2) must be moved, as the cam (N1) that has been moved forwards through the compensation must not be switched on when no product is present. This AND operation can very easily be carried out by the PLC logic module in the CamCon cam switching mechanism. However, it has one decisive disadvantage; the light barrier position may not leave the expected range of the cam switching position. But as this is very dependent on the speed of the plant and the speed compensation that has been set, an adjustment or changing of the delay time due to wear and tear on the valve can cause problems. In addition, installing a light barrier close to the adhesive station is not practical or not possible, as when the optics are soiled this can very quickly lead to malfunctions.



#### Solution 3, with light barrier S3 at any chosen position:

By using a shift register the product (P) can be tracked as it passes through the plant. The light barrier (S3) can now be installed at any position before the adhesive station. The AND operation of the light barrier signal and the cam is carried out at the output of the shift register at the time of adhesion. However, this causes the same adjustment problems as in solution 2.

#### Solution 4, shift register with speed compensation and light barrier S3:

By using a shift register with speed compensation the result of the AND operation between the cam and the light barrier signal (S3) can be read directly into the shift register as an input bit, as it is not the cam but rather the output of the shift register that is shifted in relation to the speed of the plant.

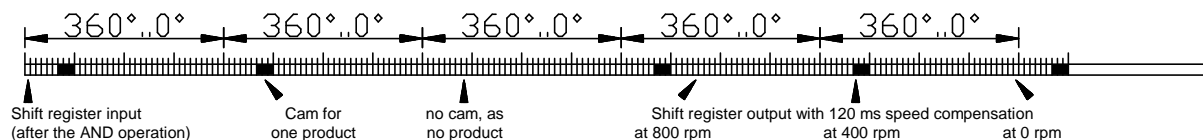

The cam is programmed directly at the required position of the adhesion point without programmed speed compensation. The necessary compensation is entered as a parameter in the shift register functional module.

The normal actual value (angle-synchronous) of the cam switching mechanism is used as the clock or timing signal for the shift register.



### 5.8.7.1. The parameters of the angle-synchronous shift register

If the cursor in the area of the functional module is on the respective output number in the O, M or X range, the angle-synchronous shift register can be selected by pressing the  key.

**Note:** The angle-synchronous shift register is now available when the variable "Shift" is set at greater than 0 and when sufficient shift registers are still available. For further details, see chapter "3. Configuration of the PLC" on page 8.

Structure and parameters of the shift register module:

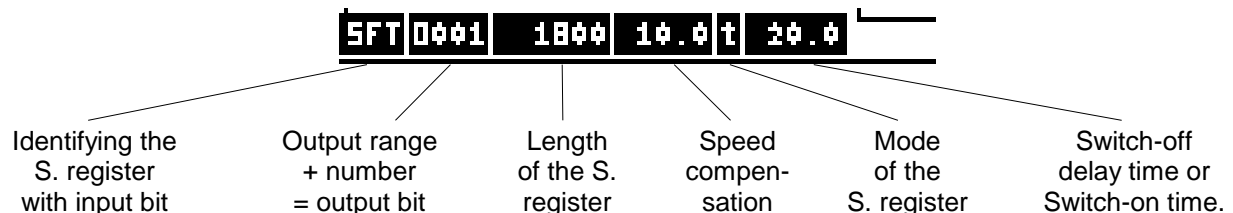

First program the necessary operation. For further details, see chapter "9.7. Example of an angle-synchronous shift register" on page 33.

The mode and switching behaviour at the output of the shift register can be selected by pressing the  key in the area of the functional module. There are three variants to choose from:

- 

Path – path output with speed compensation for the cam switching on and off points equal.
- 



Path – path output with speed compensation for the cam switching on and off points separately adjustable.
- 

Path – time output with speed compensation for the switch-on point and the switch-on time.

Entry of the parameters for the shift register is initiated by pressing the  key.

The first step is to enter the length of the shift register in units of the actual value display . For instance, this could be the distance between the light barrier and the adhesive station from the example described above.

**Note:** The maximum length of the shift register is limited by the value that is entered in the "Shift" variables "\*". Always define this variable greater than the length of the longest shift register, so that the shift register has a certain amount of play in the case of a possible short change of direction during the start-up phase of the plant. For further details, see chapter "3. Configuration of the PLC" on page 8.

If the length is confirmed with the  key, you can enter the compensation . Here, enter the first speed compensation value.

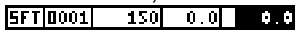
If this is confirmed, and if the shift register is set at mode 2, you can enter the 2<sup>nd</sup> speed compensation value .

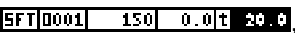
If the shift register mode is set at 3 , the switch-on time is entered here.

The speed compensation and the switch-on time for the path – time function now influences the output of the shift register in relation to the speed of the plant.

**Note:** All time entries in milliseconds (ms) have a decimal point.

**Attention:** If the switching-off-point overtakes the switching-on-point in mode 2, this results in a non-defined output-signal!

## 6. Display of the in- and output states

If you have to check the states of the in- and outputs during operation, you can do this in the automatic display of the CamCon. Exit the PLC module by pressing the **ESC** key, and select the menu point **"Visual mode"** in the CamCon's main menu. The standard display appears.

Using the keys **◀** and **▶** you can leave the standard display and switch to the displays of the different in- and outputs.

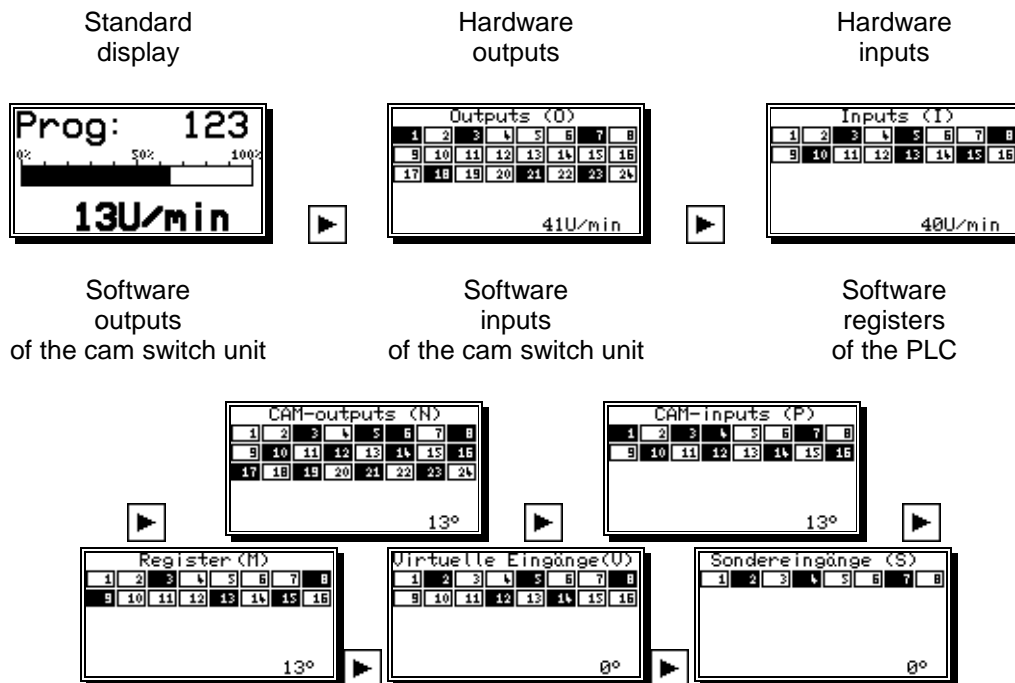

An inverse displayed field shows an active signal. The lower part of the display always displays the position or the speed of the cam switch unit. You reenter the main menu of the CamCon by pressing the key **ESC**.

## 7. The text display of the PLC module

The PLC module of the CamCon offers the user an additional text display, that can display up to 200 different messages. This display is an optional feature that has to be announced ordering the PLC-unit.

### 7.1. Programming of a message

Messages can be entered in the standard function component, the set - reset function component and in the data flip - flop function component.

Standard  
function component  
without storage  
no acknowledgement  
necessary



Set - reset  
function component  
with storage  
acknowledgement through  
keyboard or input

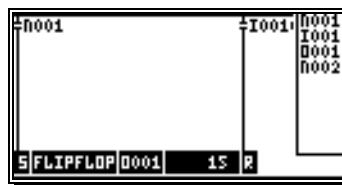

Data flip - flop  
function component  
with storage  
acknowledgement through  
keyboard or input

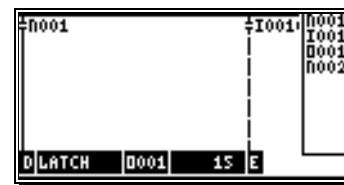

Set - reset  
function component  
with storage  
without reset requirements  
Acknowledgement is made through the keyboard



For the input of the message text the cursor has to be within the range of the function component, recognizable by the inverse display of the function component. By pressing the **#** key you initiate the input.

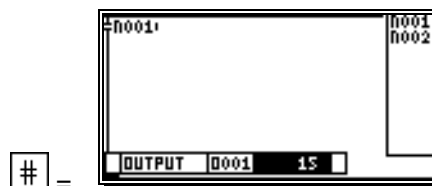

Enter the number of the message that is supposed to be shown during a true logic result. The priority of the message depends on its number. The message with the number 1 has the highest priority. After the input of a number between 1 and 200, it has to be confirmed by pressing the **CR** key. If instead of pressing the key **CR** you press the **#** key, you enter the "Infotext editor" for the input of the text of the corresponding message.

To delete the connection between the message text and the function component, enter 0 at the priority number; this does not erase the text itself.



After confirming the message number ( Info number ) by pressing the **CR** key, you enter the input of the first text line (see chapter 7.2. Text input). There are 4 lines available with 21 characters each. If the first line is less than 10 characters, this line is later displayed in twice the normal height.



Example of a display with double height:

If the input of the text lines is confirmed with the **CR** key, you reenter the input of the message number ( Info number ). Here you can enter another message number and edit the message, or you can exit the "Info text editor" by pressing the **ESC** key.

If you want to delete the whole message, you have to delete every line using the **BS** key.

## 7.2. Text input

With menu points, in which texts have to be implemented, the **◀** and **▶** keys function together with the **▼** and **▲** keys like a coordinate control. You select the desired position for the first character, using the **◀** and **▶** keys. Then you can choose the character with the **▼** and **▲** keys, by going up and down through the alphabet or the ASCII characters. If you move the cursor to the right with the **▶** key, character entered prior to this will appear in the new position of the cursor, simplifying making repeated inputs of the same character.

If you have made an error you can go back to the wrong character to correct it, using the **◀** key or the **BS** key. This will cause the other characters to become erased. To abandon the input press the **CR** key.



**Attention:** The software for the text input at the CamCon has changed since EPROMS of 1/97. The selection of desired characters is now realized with keys **⌈** and **⌋**. With keys **◀** and **▶** you can now position the cursor anywhere in the previously entered text. You can overwrite characters, insert characters by pressing the **INS** key or delete characters with keys **DEL** or **BS**.

**Note:** The text input is also possible directly via PC.

### 7.3. The display of the message

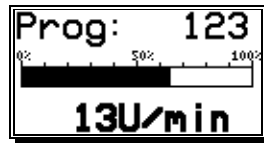
If the CamCon is in the standard display,



a true logic result makes the display show the message with the highest priority. If there are several results, you can scroll through the messages, using the keys  and .

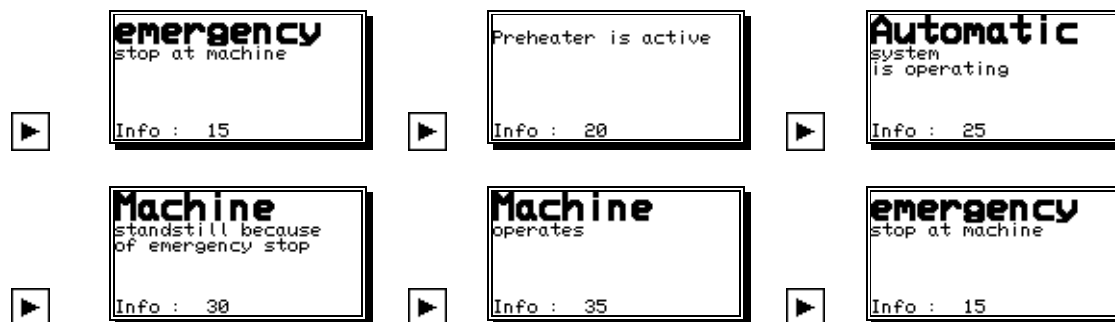

### 7.4. Acknowledging the message

If the results of the displayed messages become false, the messages automatically disappear, and the standard display returns after a short while.

A message stored by a set - reset or data flip - flop function component can be acknowledged by pressing the  key. Optionally, it is possible to acknowledge the displayed message by selecting a component with the reset option.

#### 7.4.1. Suppressing messages for 30 seconds







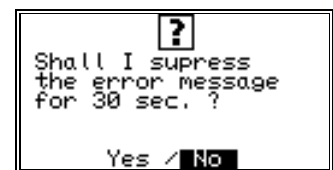

















To be able to watch the in- and output states of the CamCon, you can suppress the message system for 30 seconds. For this option, press the  key while a message is displayed. The following question appears:

If you answer with YES, all further messages are suppressed for 30 seconds.

Should you return to the ComCon main menu and go back again during this time, the message system is reactivated immediately.



## 8. Outline of the key functions

	Cursor downwards.
	Cursor upwards.
	Cursor to the left.
	Cursor to the right.
	Scrolling backwards through the in- or output types.
	Scrolling forwards through the in- or output types.
	No current function.
	Input of times in the timer function or the input of message numbers.
	Exits the PLC menu or cancels the input of a number.
	Deletion of a whole network and then setting the standard logic.
	Deletion of single characters.
	Direct input of an in- or output number.
	Switching the trigger edge for timers and counters.
	Copying a linked network into the clipboard and calling up the cross reference list.
	Numeric key; deletion of switching symbols; selection of a function component
	Numeric key; inserts switching symbols; selection of a function component
	Numeric key; inserts switching symbols; selection of a function component
	Numeric key; inserts switching symbols; selection of a function component
	Numeric key; inserts switching symbols; selection of a function component
	Numeric key; inserts switching symbols; selection of a function component
	Numeric key; inserts switching symbols; selection of a function component
	Numeric key; inserts switching symbols; selection of a function component
	Numeric key; inserts switching symbols; selection of a function component
	Numeric key; inserts switching symbols; selection of a function component

## 9. Examples for using the PLC Logic Module

### 9.1. Output deactivation



Output 1 of the CamCon is enabled when inputs 1 and 8 are active.

### 9.2. Output dependent on the rotation direction



Output 1 of the CamCon is enabled when the rotation direction output 32 is **active**.  
This is the case, if the direction of the rotation is **positive**

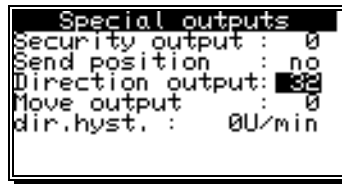

Output 1 of the CamCon is enabled when the rotation direction output 32 is **deactivated**.  
This is the case, if the direction of the rotation is **negative**.

### 9.3. Output with a separate speed compensation for activation and deactivation point

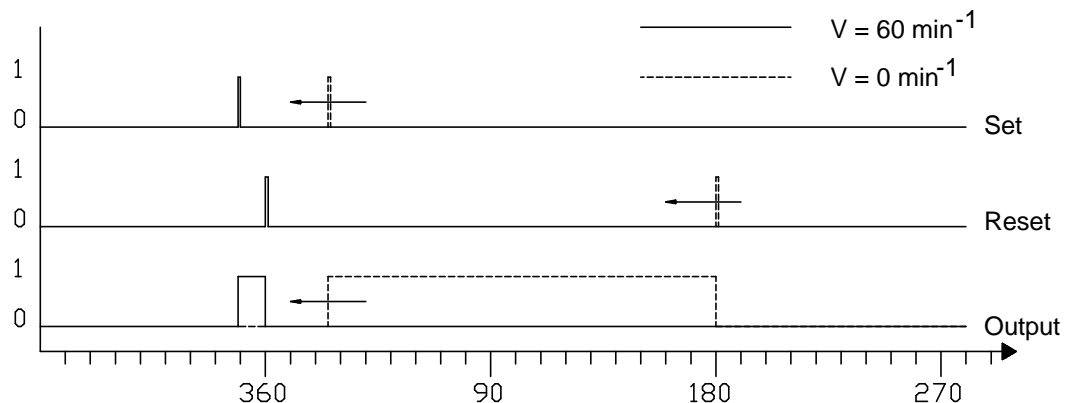
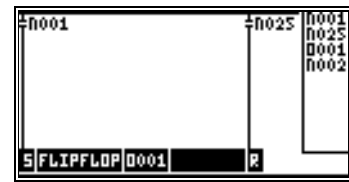
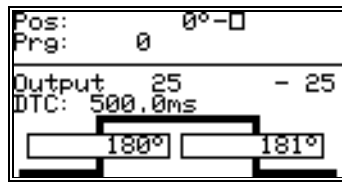
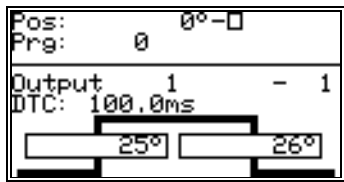

The activation point of the output is shifted by 100ms, the deactivation point by 500ms. This decreases the time it takes to activate the output. The limit of the speed is reached, if the deactivation point gets ahead of the activation, or if the set- reset cam is not long enough. In this example the logic has to be deactivated for the change of the rotation direction, since it does not work independent of the rotation direction.

**Note:** if using a CamCon Software 5/2002 or later ist this feature is integrated in the Camcontroller itself.

### 9.4. Edge evaluation



Register 2 is activated for one cycle, when the signal on input 1 changes from 0 to 1.

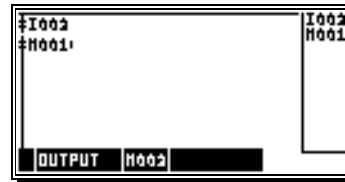

Register 2 is activated for one cycle, when the signal on input 2 changes from 1 to 0.

### 9.5. Toggle function or power surge function



Register 2 is switched on every positiv edge on input 1.

### 9.6. Simple shift register function

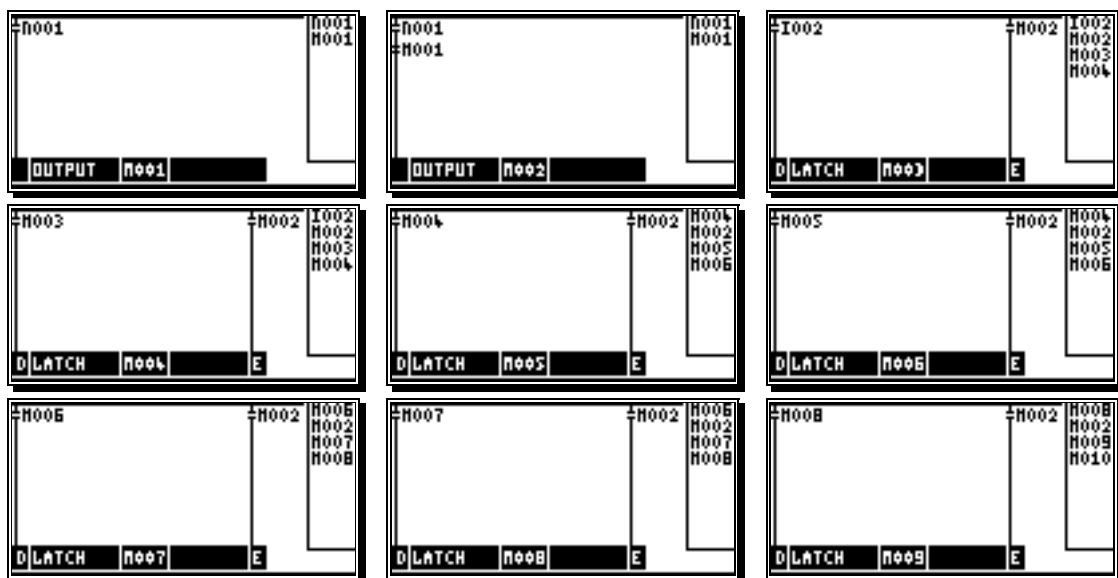

With the positive edge on the cam 1 (N001 = shift register clock) the signal at the input 2 (I002 = data) will transferred in the register 3 (M003). With the same edge the current conditions of the following registers 4 - 9 are transferred to the next. In this example you have a shift register with 7 cells, where register 3 (M003) the input and register 9 (M009) the output of the shift register represents.



### 9.7. Example of an angle-synchronous shift register

This is an example for the plant described in chapter "5.8.7. The synchronous shift register".

In order to be able to define the position of the light barrier as freely as possible, it is practical to store the signal of the light barrier (input I001) in a flag (M005) and then use this for the AND operation. The M005 flag is reset with the negative edge of the cam N001.



If a positive edge is detected at input I001, the M005 flag is set.  
 (M001 and M002 edge flag input I001).



If the cam N001 is switched off (negative edge), the M005 flag is reset.  
 (M003 and M004 edge flag cam N001).



Flag M005, memory for a product is detected.

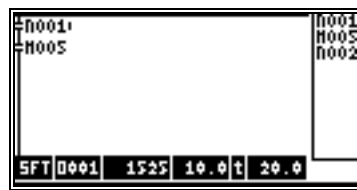

If a product is detected (flag M005 active) and the cam N001 is active, the result is entered in the shift register.

After 4 revolutions and 85 degrees (1525/360), the signal appears at the output of the shift register and switches output O001 on for 20.0 ms (path – time cam).

At a speed of 60 rpm, the output is already active at a path of 4 revolutions and 81.4 degrees (speed compensation 10.0 ms) for 20.0 ms.

**Note:** The cams N001 must be entered without speed compensation.

## 10. User menu or OP function

Here you can define your own entries or display functions. This function makes it easier for the end customer to change and check cams, delay times and variables of the PLC logic module, without having to intervene in the sub-menu of the device. This function reduces the risk of operator error or incorrect entry to a minimum. The defined entry or display functions are integrated into the standard display of the CamCon. A maximum of 10,000 menu pages are available (depending on the EEPROM storage capacity).

If you selected the menu item "user menu" in "user config.", the menu shown below is displayed:

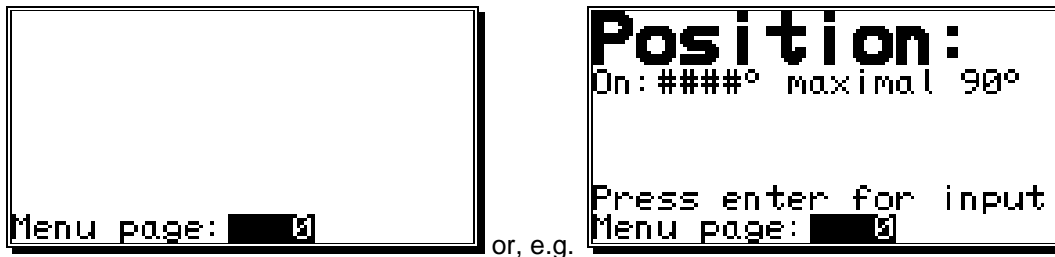

### 10.1. Entering a menu page

Every menu page consists of 8 lines with up to 21 ASCII characters; where the '#' character is reserved as a wild card for entering variables and may not be used for any other purpose. While entering data into the standard display the actual value, the speed or an error message is always displayed in the 8<sup>th</sup> line. The user cannot use this line. When definitions are being made the number of the menu page is displayed in this line. If a maximum of 10 characters are entered in the 1<sup>st</sup> line the first line is shown as twice the normal size and the second line cannot be used.

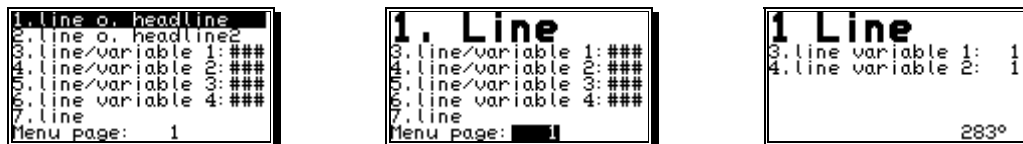

The first two illustrations show the screen during definition, the last shows the screen during entry in the standard display.

#### 10.1.1. Selecting a user menu for definition

To select the required menu page the menu page number must be displayed in the 8<sup>th</sup> line of the screen. This representation corresponds to the main menu of the menu definition. Now, the required menu can be selected directly by entering the required number.

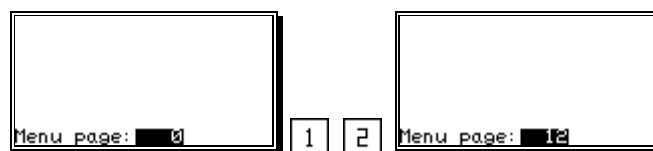

By pressing the keys or it is possible to leaf through the previously defined menus.



### 10.1.2. Defining the menu page

If you have selected the menu page to be defined (see chapter "10.1.1. Selecting a user menu for definition") the definition is started by pressing the **CR** key. The following menu is displayed:



By pressing the keys **▼** and **▲** you now select the lines that you wish to edit and confirm this with the **CR** key. If lines 1, 2 or 7 are selected, the line can either be defined as "1 text" or "2 variables" lines and can thus be used as a heading.

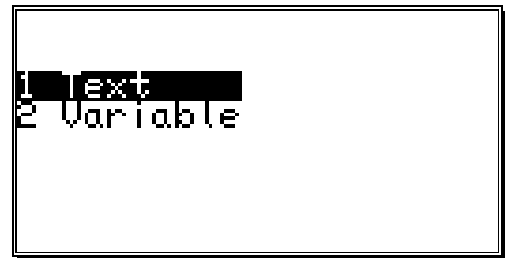

#### 10.1.2.1. Menu line 1 or heading

First, the heading of the menu page is entered in menu line 1. A user-defined text with a maximum length of 21 characters can be shown (see chapter "7.2. Text input" on page 28). If only 10 characters are entered the first line is shown at twice its normal height and the 2<sup>nd</sup> line or "2<sup>nd</sup> heading" cannot be used.

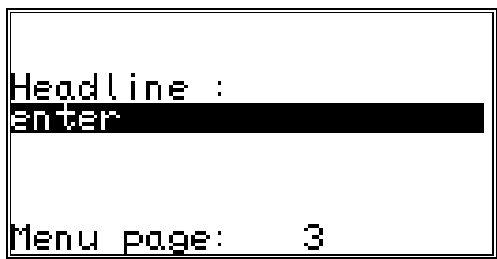

By pressing the **CR** key the "heading" is saved and the program returns to the line selection menu. Here you can again select the next line with the **▼** and **▲** keys and by entering **CR**, you either enter the "2<sup>nd</sup> heading" or the first variables.

#### 10.1.2.2. Menu lines 2 - 7 or variable access

In these menu lines access to the actual variables is defined. If you have selected line 2 or 7 for editing and not yet made any entries in the lines, you can define two additional text lines in the menu here ("2<sup>nd</sup> heading" and "footer") or you can enter the variable access.

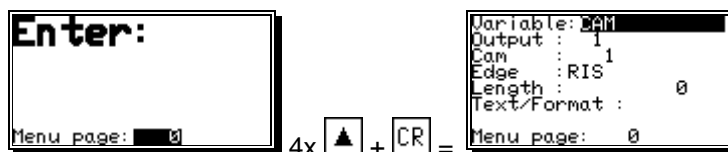

In the variable field use the **▶** and **◀** keys to select the variable type. You have a choice of 5 types. There are: "CAM", "PLC ACTUAL", "PLC TARGET", "DELAY TIME (or "speed compensation")" and the bit variable "V-Input". Depending on the variable type that is selected, another menu with the respective different parameters is set up. Save the selected variable type with the **CR** key. Then continue entering the variable parameters. Parameter entry includes two screens for each variable type. You can change between the two screens by pressing the **CR** key on the "Pretext/Format" field. When a parameter is entered it must be saved by pressing the **CR** key, which also serves to select the next entry field or the next parameter. The functions of the individual parameters will be described in the following chapters.

### 10.1.2.3. Variable types

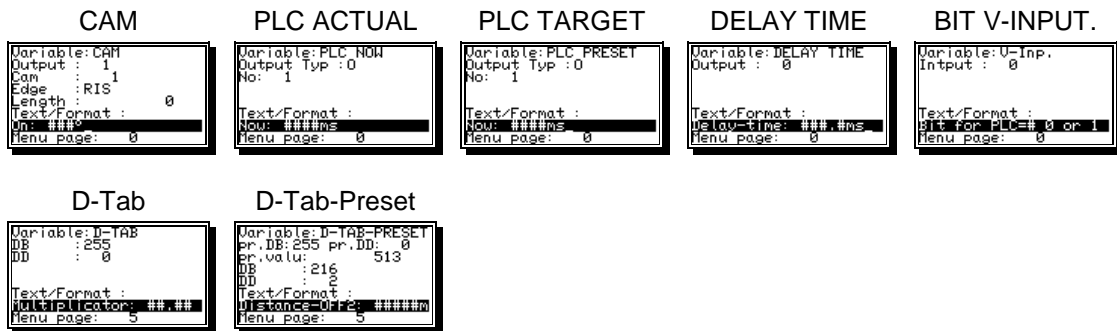

#### 10.1.2.3.1. Parameters of the CAM variables

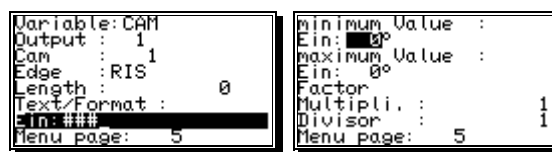

The variable "CAM" is used to enter cams and requires a total of 9 parameters:

1. Output                      Output number of the cam output.
  2. Cam                         Cam number.  
The number of the cam on a cam track (output) with several cams.
  3. Flank                        The switch-on or switch-off point of the cam is entered or displayed.
  4. Length                      The length of the cam.  
If this value is set at 0, this changes the switch-on or switch-off point of the cam.  
A value not equal to 0 always creates a cam with a fixed length, where the flank defines which direction the cam is programmed in.
  5. Pretext/format             Entry format and unit text.  
This is where the actual entry line is defined; hashes are used as wild cards for the actual number value. It is thus possible to integrate a descriptive text, the actual number value, a decimal point or a unit in the entry line (e.g. "On:###.##mm") For further details, see chapter "7.2. Text input", page 28.
- Please note:** The number of hashes must be the same as the number of decimal points for the entry value. If a negative sign is required, you will require another wild card.
6. Minimum value             The bottom limit for the entry value, no entries can be made below this value.
  7. Maximum value            The top limit for the entry value, which cannot be exceeded.
- Note:** If these two values are set at 0, no entry can be made. The variable is only displayed.
8. Multiplier                 Multiplies and displays the actual (processed by CamCon) value.
  9. Divisor                     Divides and displays the actual value.

**Please note:** When entering values the value is converted by the factor and saved as a true value. The minimum, maximum and length values must take account of the factor, as these are not converted.

### 10.1.2.3.2. Parameters of the PLC ACTUAL/NOW variable

```
Variable: PLC NOW
Output Typ : 0
No: 1

Text/Format :
Ein: #####ms
Menu page: 5
```

```
Minimum Value :
Delay time 0.0ms
maximum Value :
Delay time 0.0ms
Factor
Multipli. : 1
Divisor : 1
Menu page: 5
```

The "PLC ACTUAL (or "NOW") variable is required to enter and display actual values of the times and counters of the PLC logic module. A total of 7 parameters are required:

1. Output type            Output type in the PLC logic module in which the number or time function is stored (e.g. O, P, M, or X range).
2. No.:                    The number of the counter or time function in the O, P, M, or X range.
3. Pretext/format        Entry format and unit text.
4. Minimum value        The bottom limit for the entry value, no entries can be made below this value.
5. Maximum value        The top limit for the entry value, which cannot be exceeded.
6. Multiplier            Multiplies and displays the actual (processed by CamCon) value.
7. Divisor                Divides and displays the actual value.

**Please note:**            For parameters 3, 4, 5, 6 and 7 see chapter "Parameters of the CAM variables", page 3.

### 10.1.2.3.3. Parameters of the PLC PRESET variables

```
Variable: PLC PRESET
Output Typ : 0
No: 2

Text/Format :
Ein: #####ms
Menu page: 5
```

```
Minimum Value :
Delay time 0.0ms
maximum Value :
Delay time 0.0ms
Factor
Multipli. : 1
Divisor : 1
Menu page: 5
```

The "PLC PRESET" variable is required to enter and display target values of the times and counters of the PLC logic module. A total of 7 parameters are required:

1. Output type            Output type in the PLC logic module in which the number or time function is stored (e.g. O, P, M, or X range).
2. No.:                    The number of the counter or time function in the O, P, M, or X range.
3. Pretext/format        Entry format and unit text.
4. Minimum value        The bottom limit for the entry value, no entries can be made below this value.
5. Maximum value        The top limit for the entry value, which cannot be exceeded.
6. Multiplier            Multiplies and displays the actual (processed by CamCon) value.
7. Divisor                Divides and displays the actual value.

**Please note:**            For parameters 3, 4, 5, 6 and 7 see chapter "Parameters of the CAM variables", page 3.

#### 10.1.2.3.4. Parameters of the DELAY TIME variables

```
Variable: DELAY TIME
Output : 0

Text/Format :
Delay-time: ###.##ms
Menu page: 0
```

```
Minimum Value :
Delay time 0.0ms
Maximum Value :
Delay time 0.0ms
Factor
Multipli. : 1
Divisor : 1
Menu page: 5
```

The "DELAY-TIME" variable is required to enter and display the programmed delay time of a cam output. A total of 6 parameters are required:

- |                   |  |
|-------------------|--|
| 1. Output         | Output number.   |
| 2. Pretext/format | Entry format and unit text.  |
| 3. Minimum value  | The bottom limit for the entry value, no entries can be made below this value. |
| 4. Maximum value  | The top limit for the entry value, which cannot be exceeded.                   |
| 5. Multiplier     | Multiplies and displays the actual (processed by CamCon) value.                |
| 6. Divisor        | Divides and displays the actual value.   |

**Please note:** For parameters 3, 4, 5, 6 and 7 see chapter "Parameters of the CAM variables", page 3.

#### 10.1.2.3.5. Parameters of the bit V-input variables.

```
Variable: V-Inp.
Input : 0

Text/Format :
Bits for PLC# 0 or 1
Menu page: 5
```

```
Minimum Value :
Bits for PLC=0 0 or 1
Maximum Value :
Bits for PLC=1 0 or 1
Factor
Multipli. : 1
Divisor : 1
Menu page: 5
```

The "V-input" variable is required to influence the V inputs of the PLC logic module. Entering 0 or 1 controls the V input accordingly. A total of 6 parameters are required:

- |                   |  |
|-------------------|--|
| 1. Input          | V input number.                            |
| 2. Pretext/format | Entry format, one # and user-defined text. |
| 3. Minimum value  | must always be 0.                          |
| 4. Maximum value  | must always be 1.                          |
| 5. Multiplier     | must always be 1.                          |
| 6. Divisor        | must always be 1.                          |

### 10.1.2.3.6. Parameters of the D-TAB variables

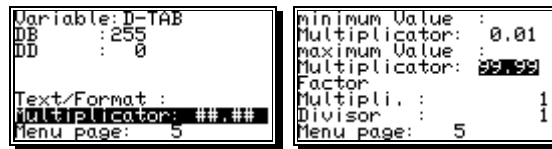

The D-Tab variable is used for simply feeding in Systemparameters and needs 7 parameters itself:

1. DB                      Number of data-sheet for your desired parameter
2. DD                      Offset of data-sheet for your desired parameter
3. Text/Format          Input form and text-input
4. minimum value        lowest possible value, inputs must not fall short this parameter
5. maximum value        highest possible value, inputs must not exceed this parameter
6. Multiplier            with which the true value (processed by the CamCon-unit) gets multiplied and displayed
7. Divisor                by which the true value (processed by the CamCon-unit) gets divided and displayed

### 10.1.2.3.7. Parameters of the D-TAB-PRESET-variables



The "D-TAB-Preset" variables is used for simply feeding in parameters off an PLC-Logic-Module and needs 10 parameters itself:

1. pr.DB                      Number of the data-sheet written before the actual value is written (preset)
2. pr.DD                      Offset in data-sheet that gets written before the actual value is written
3. pr.Value                  Value written before the actual value is written

**Note:** This enables choosing an defined PLC-Logic. Your choice is made by entering the range and it's number.  
O=0, P=256, M=512, X=768  
+ the number of 0-199 respctive 247.

**Example:** If an value in the PLC-Logic M002 shall be changed or read, you first have to enter an 512+1=513 on the pr.value in pr.DB=216, pr. DD=0

4. DB                      Number of the data-sheet of your chosen value (for a PLC always 216).
5. DD                      Offset in a datasheet of your chosen value
6. Format/Text            Inputform and -text
7. minimum value        lowest possible value, inputs must not fall short this parameter
8. maximum value        highest possible value, inputs must not exceed this parameter
9. Multiplier            with which the true value (processed by the CamCon-unit) gets multiplied and displayed
- 10.Divisor                by which the true value (processed by the CamCon-unit) gets divided and displayed

**Attention:** You are not able to program Cams using the T-TAB or D-TAB\_PRESET

**Note:** For the values for DB and DD see the RK512-manual on the internet:  
<http://www.digitronic.com/ftp/rk512.pdf>.

### 10.1.3. Deleting a user menu

To delete a user menu, select the menu that is to be deleted and press the **DEL** key. Answer the following question with "YES".

To delete a line in a user menu, select the line that is to be deleted in the required menu and press the **DEL** key. Answer the following question with "YES". In addition, a menu line is deleted if there are no more '#' characters in the "Pretext/Format" line and if you answer the following question with "YES".

### 10.2. Selection, variable entry and displaying the user menu in the standard display

To select variable entry or display the defined user menu, select the standard display. Here, press the **▶** key, which displays the first defined entry or display menu. Each time you press the **▶** key, you shift to the next menu (always in the ascending order of the menu numbers). If no menu is found, the status display of the outputs is displayed. Pressing the **CR** key in the required menu initiates the entry. You must then enter and confirm the user number for the user menu. See chapter "Key allocation" in the CamCon cam switching mechanism logic manual. If the code is accepted, all variable of this menu can be changed within their permissible range. If several variables are to be entered, these are selected in sequence by pressing the **CR** key or the **▼** and **▲** keys. The entry is concluded by pressing the **CR** key on the last entry field.

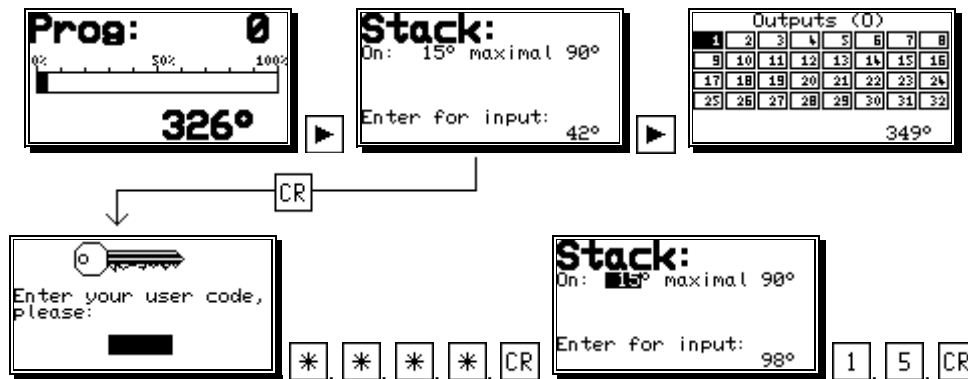

**N.B.** Every entry of a variable must be saved by pressing the **CR** key.

The entry can be cancelled at any time by pressing the **ESC** key.

#### 10.2.1. Error message during entry

If you have made an error when defining the menu page, when you attempt to enter a variable in the standard display the following error message will be displayed. "Error in line X !"

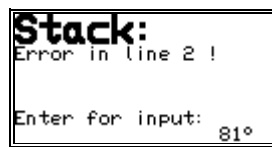

The reason for this message could be for example:

- accessing an undefined PLC range.
- accessing a cam in a range that does not exist.



### 11. RAM memory in the PLC Logic Module

In the CamCon with the PLC Logic Module you need additional RAM memory for the calculation and the deposit of the logic matrix. This should be kept in mind when calculating the RAM memory.

$$\begin{aligned} \text{Needed RAM memory in bytes} &= 2 * (\text{Inputs} + \text{Outputs} + \text{Registers}) \\ &+ (772 * \frac{\text{Inputs} + \text{Outputs} + \text{Registers}}{8}) + (\text{Timer} * 12) \\ &+ (\frac{\text{Shift register}}{8} * \text{Shift cells}) \end{aligned}$$

$$\begin{aligned} \text{memory} &= 2 * (16 + 16 + 8) \\ &+ (772 * \frac{16 + 16 + 8}{8}) + (16 * 12) \\ &+ (\frac{16}{8} * 7200) \\ &= 18532 \text{ bytes} \end{aligned}$$

18532 bytes of additional RAM memory are needed.

### 12. EEPROM memory in the PLC Logic Module

In the CamCon with the PLC Logic Module you need additional 72 bytes of the EEPROM memory for every programmed logic network. The programming of an error message needs additional 90 bytes of the EEPROM memory. This should be kept in mind when calculating the EEPROM memory.

**Example:** The cam switch unit occupies 1500 bytes of the EEPROM memory. With the smallest memory size of 2048 bytes, you can still program up to 7 logics.

### 13. Technical data of the CamCon PLC Logic Module

Inputs (Hardware) .....	up to 200
Outputs (Hardware).....	up to 200
Registers X and M.....	up to 496
Timer .....	up to 200
Virtual inputs .....	up to 248 (via RS232, S5-L1 or S5 / S7 / ControlLogix backplain).
Special inputs.....	up to 248, currently used 96.
Shift register with DTC .....	up to 200 with up to 999999 shift cells
Error message display .....	with up to 200 texts
Cycle time .....	for 16 in- and 32 outputs including cam switch unit with a speed compensation of about 1.3ms.
Cycle time .....	for 200 in- and 200 outputs including cam switch unit with a speed compensation of about 7.5ms.
RAM memory requirements .....	see chapter 11. RAM memory in the PLC Logic Module
EEPROM memory requirements. ....	see chapter 12. EEPROM memory in the PLC Logic Module
Optionally (only CamCon DC51) .....	Hardware PLC - Accelerator PLC-Boost.
Cycle time with PLC-Boost.....	for 200 in- and 200 outputs, 496 Registers, 248 V - and 248 S inputs including cam controller with speed compensation: about 3.2ms.

### 14. Programing of the PLC-Logic-Module on DC300 or 1756-DICAM

When programing for a CamCon DC300 or 1756-DICAM please generate your Logic OFFLINE using DIGISOFT 2000, version 2.03 or later for MS-Windows (<http://www.digitronic.com/ftp/ds2000.exe>). Also read page 8, chapter "3. Configuration of the PLC".

**Attention:** please use for OFFLINE-programing exactly the same values, as programed by data-sheet respective data-component No.203. The following parameters must be adjusted before starting to program your Logic:

**Menu sytem-setting - Sub-Menu: Path-measuring:**

path-measuring = datawords: 0 - 7  
gear unit = datawords: 10 + 11

**Menu sytem-setting - Sub-Menu: system-improvement:**

cam switch Input = dataword: 30  
cam switch Output = dataword: 31

**Menu unit configuration - Sub-Menu: hardwareconfig:**

physical inputs = dataword: 46  
physical outputs = dataword: 47

**Menu unit configuration - Sub-Menu: PLC configuration:**

PLC-Modul (on/off/rem) = datawordt: 45  
M-register = dataword: 48  
X-register = dataword: 49  
Timer/Cnt. = dataword: 50  
virtual inputs = dataword: 51  
special inputs = dataword: 52  
angle-synchronous shift-register = datawords: 64 + 65

After having put in and saved your Logic, the essential data will be exportet as decimal numbers. Feed these into a data record (data sheet 216) of your components and transfer it to the Camcon.

**Note:** Using DIGISOFT 2000, version 2.16 respective 2.19 or later you can extract the complete data-ammount of a CamCon-Project into a Step 7 AWL- and Controllogix L5K-format and integrate into components allready existing.

**Example:**

In this example output 2 is only avaiable if input S006 (ControlLogix or S7 - CPU in RUN) is active, the cam-output 2 as well as the V002-input (ControlLogix loca:O-area / S7 PA-range) or the V008 - Input (ControlLogix local:O - range / S7 PA - range) are active.



When feeding a datablock with the following numbers and sending it to a CamCon, the logic network will be immediatly programed and executed.

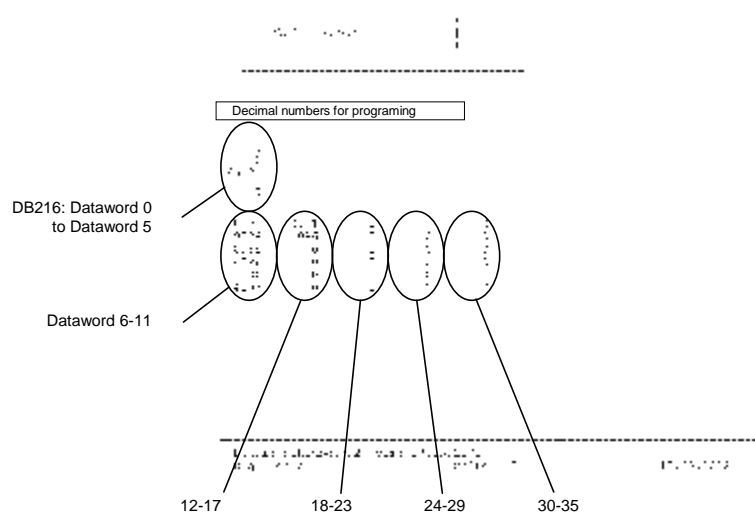

## 15. Structure of a logic network in the memory

To be able to control the PLC Logic module of the CamCon DC115 via a S5-AG, it is necessary to know the structure of the logic network in the memory.

**Note:** Printing a logic the DIGISOFT 2000 version 2.03 also prints out it's memory-structure meanwhile the version 2.19 or later are able to export a memory-structure, so you are able to adopt it in 1:1 scale on your SPS.

A logic network consists of 6 x 5 input cells as well as one output cell (the function component). Every input cell requires 16 bits of memory. The output cells require a total ammount of 64 bits. The memory block of a logic network is always read or written completely (68 bytes).

16Bit input field 1. column / 1. line	16Bit input field 2. column / 1. line	16Bit input field 3. column / 1. line	16Bit input field 4. column / 1. line	16Bit input field 5. column / 1. line
16Bit input field 1. column / 2. line	16Bit input field 2. column / 2. line	16Bit input field 3. column / 2. line	16Bit input field 4. column / 2. line	16Bit input field 5. column / 2. line
16Bit input field 1. column / 3. line	16Bit input field 2. column / 3. line	16Bit input field 3. column / 3. line	16Bit input field 4. column / 3. line	16Bit input field 5. column / 3. line
16Bit input field 1. column / 4. line	16Bit input field 2. column / 4. line	16Bit input field 3. column / 4. line	16Bit input field 4. column / 4. line	16Bit input field 5. column / 4. line
16Bit input field 1. column / 5. line	16Bit input field 2. column / 5. line	16Bit input field 3. column / 5. line	16Bit input field 4. column / 5. line	16Bit input field 5. column / 5. line
16Bit input field 1. column / 6. line	16Bit input field 2. column / 6. line	16Bit input field 3. column / 6. line	16Bit input field 4. column / 6. line	16Bit input field 5. column / 6. line
16Bit output field of the funtion component		32Bit value of the output field		16Bit reset field for the timer
16 Bit second TZK-value for shift-register/starting- time in shift-register mode 2.		8 Bit shift-register mode 0..2.		

**Note:** A CamCon DC115 only uses 16 of 32Bit for the value of the output-field

### 15.1. Structure of the output field (function component)

The number of the corresponding output or register (e.g. 1..248) is saved in the first 8 bits (Bit 0..7).

In the next 4 bits (Bit8..11) the output type is set to "O", "P", "X" or "M". The 11th bit must always be set to 1, and the 10th bit must always be set to 0. There are only three valid settings.

Bit 11	Bit 10	Bit 9	Bit 8	Output type
0	0	0	0	Invalid setting
0	0	0	1	Invalid setting
0	0	1	0	Invalid setting
0	0	1	1	Invalid setting
0	1	0	0	Invalid setting
0	1	0	1	Invalid setting
0	1	1	0	Invalid setting
0	1	1	1	Invalid setting
1	0	0	0	Output range <b>O</b> (physical output)
1	0	0	1	Output range <b>P</b> (cam switching unit input)
1	0	1	0	Output range <b>M</b> (register)
1	0	1	1	Output range <b>X</b> (register)
1	1	0	0	Invalid setting
1	1	0	1	Invalid setting
1	1	1	0	Invalid setting
1	1	1	1	Invalid setting

In the last 4 bits (Bit 12..15) the type of the function component is selected.

Bit 15	Bit 14	Bit 13	Bit 12	Function component
0	0	0	0	Standard
0	0	0	1	Set - Reset
0	0	1	0	Data Flip - Flop
0	0	1	1	Toggel Flip - Flop
0	1	0	0	SI - Timer
0	1	0	1	SV - Timer
0	1	1	0	SE - Timer
0	1	1	1	SA - Timer
1	0	0	0	inverse SI - Timer
1	0	0	1	inverse SV - Timer
1	0	1	0	Forwards counter with positive triggering
1	0	1	1	Forwards counter with negative triggering
1	1	0	0	Backwards counter with positive triggering
1	1	0	1	Backwards counter with negative triggering
1	1	1	0	Shift register
1	1	1	1	Invalid setting

## 15.2. Structure of the input cells

In the first 8 bits (Bit 0..7) the number of the corresponding input, output or register (e.g. 1..248) is saved.

In the next two bits (Bit 8+9) you can set the in- or output type, depending on the 11th bit. Is the the 11th bit set to 1, a backwards leading output is used in the input cell.

Bit 11	Bit 9	Bit 8	In - or output type
0	0	0	Input range <b>N</b> (cam)
0	0	1	Input range <b>I</b> (physical input)
0	1	0	Input range <b>V</b> (virtual input)
0	1	1	Input range <b>S</b> (special input)
1	0	0	Output range <b>O</b> (physical output)
1	0	1	Output range <b>P</b> (cam switching unit input)
1	1	0	Output range <b>M</b> (register)
1	1	1	Output range <b>X</b> (register)

In the 10th bit the OR linkage is adjusted.

Bit 10	OR linkage (Yes / No)
0	$\overline{\text{I}}\text{N}001$
1	$\overline{\text{I}}\text{N}001$

The symbol of the input cell is defined in the last 4 bits (Bit 12..15).

Bit 15	Bit 14	Bit 13	Bit 12	Symbol
0	0	0	0	empty field
0	0	0	1	conduction =
0	0	1	0	normally open = $\overline{\text{I}}\text{N}001$
0	0	1	1	normally closed = $\overline{\text{I}}\text{N}001$

Example for the structure of an input cell:

Symbol	Bit 15..12	Bit 11	Bit 10	Bit 9+8	Bit 7..0
$\frac{1}{7}I007$	0010	0	0	01	0000 0111
$\frac{1}{7}N002$	0011	0	0	00	0000 0010
$\frac{1}{7}M008$	0010	1	0	10	0000 1000
$\frac{1}{7}P001$	0010	1	0	01	0000 0001
$\frac{1}{7}U005$	0010	0	0	10	0000 0101
$\frac{1}{7}I007$	0010	0	1	01	0000 0111
$\frac{1}{7}N002$	0011	0	1	00	0000 0010
$\frac{1}{7}$	0001	0	1	00	0000 0000

Example for the structure of an output cell:

Symbol	Bit 15..12	Bit 11..8	Bit 7..0	Bit 0..16 for value
$\frac{1}{4}CNT UP$ $\frac{0001}{}$ $\frac{100}{}$ $\frac{N002}{}$	1011	1000	0000 0001	0000 0000 - 0110 0100
only for counter only for counter				Bit 0..16 for reset field 0000 0000 - 0000 0000
$\frac{1}{7}TIME SI$ $\frac{N002}{}$ $\frac{150.0}{}$	0100	1010	0000 0010	0000 0101 - 1101 1100
$\frac{5}{7}FLIPFLOP$ $\frac{N006}{}$ $\frac{120}{}$ $\frac{R}{}$	0001	1000	0000 0110	0000 0000 - 0111 1000
$\frac{1}{7}OUTPUT$ $\frac{N006}{}$	0000	1000	0000 0110	0000 0000 - 0000 0000

**16. Key word table**

1756-DICAM .....	7; 42
Actual value.....	7
Block diagram .....	5
CE .....	2
Conduction elements .....	14
Configuration of the PLC.....	8
Contact normally closed.....	15
Contact normally open .....	14
Counter reset .....	22
Counter reset requirement, Input.....	23
Counter value, Input.....	22
CP16 .....	6; 42
Cross references.....	13
Cursor .....	11
DC300 .....	7; 42
Deleting a user menu.....	40
Display.....	26
Edge evaluation .....	32
EEPROM memory in the PLC Logic Module .....	41
Examples .....	31
Features.....	5
Function component .....	16
Function component, Backwards counter.....	22
Function component, Backwards counter, Negative edge control.....	22
Function component, Data flip - flop .....	17
Function component, Forwards counter .....	21
Function component, Forwards counter, Negative edge control .....	21
Function component, SA - timer .....	20
Function component, SE - timer .....	19
Function component, Set - reset.....	16
Function component, shift register.....	24
Function component, SI - timer.....	18
Function component, SI - timer, Negative edge control.....	18
Function component, Standard.....	16
Function component, SV - timer .....	19
Function component, SV - timer, Negative edge control .....	19
Function component, Toggle flip - flop.....	17
Function module.....	10
Functional module, shift register parameter.....	25
Infotext editor .....	27
Input of text .....	28
Introduction .....	5
Key functions, Outline .....	30
Keys .....	7
Lines, deleting .....	40
Logic field.....	10
Logic network .....	10
Logic network, Copying.....	13
Logic network, Deletion.....	13

Logic network, Selection .....	12
Logic network, Structure .....	43
Logic path symbols .....	14
Message, Acknowledgement .....	29
Message, Display .....	29
Message, number .....	7
Message, programming .....	27
millenium .....	2
OP function .....	34
Output .....	15
Output number, Selection .....	12
PDF - File .....	2
Power loss protection .....	6; 8
Power surge funktion .....	32
Principle of function .....	5
Priority .....	27
Program number .....	7
Programing, via RK512 interface .....	42
Programming .....	11
RAM memory in the PLC Logic Module .....	41
Remanency .....	6; 8
S5-L1 .....	6
Shift register, example of angle, synchronous .....	33
Shift register, length .....	25
Shift register, mode .....	25
Shift register, simple .....	32
shift register, synchronous .....	24
Standard logic .....	11
Table of contents .....	3
Technical data .....	41
Text display .....	27
Text input .....	28
Timer, Time setting .....	20
Toggle function .....	32
UP - Date .....	2
User menu .....	34
User menu, bit variable .....	38
User menu, definition .....	34
User menu, error message .....	40
User menu, heading .....	35
User menu, menu line 1 .....	35
User menu, parameter of D-TAB variables .....	39
User menu, parameter of D-TAB-PRESET variables .....	39
User menu, parameter of V input .....	38
User menu, parameters of CAM variables .....	36
User menu, parameters of the DELAY TIME variable .....	38
User menu, parameters of the PLC ACTUAL variables .....	37
User menu, parameters of the PLC PRESET variable .....	37
User menu, selecting the menu page during definition .....	34
User menu, selection and variable entry .....	40
User menu, variable type .....	35
User menu, variable types .....	36