

Digital Cam Controller

CamCon DC60/61

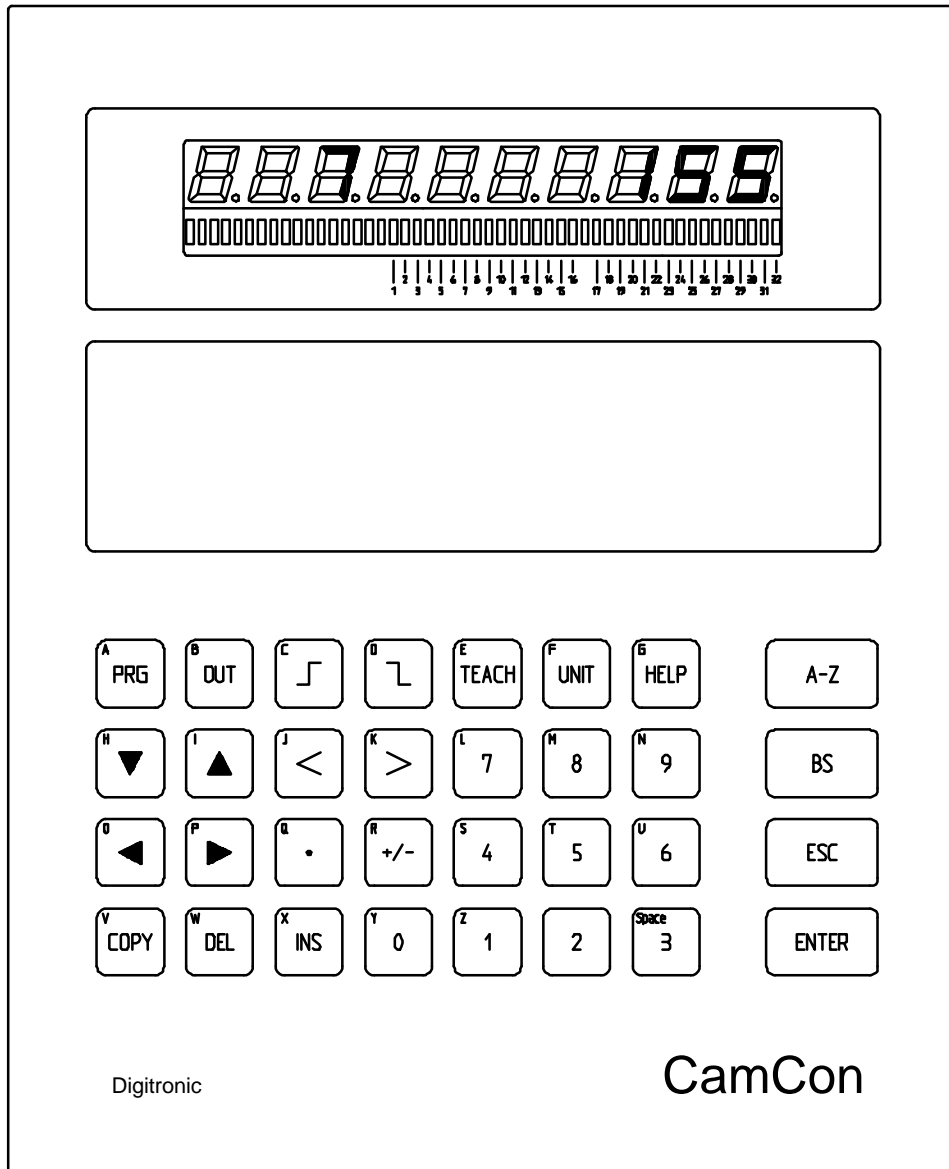

Digitronic Automationsanlagen GmbH

Nürtinger Straße 71 · D-72639 Neuffen · Tel. (+49)7025/5136 · Fax (+49)7025/83213
Auf der Langwies 1 · D-65510 Hünstetten-Wallbach · Tel. (+49)6126/9453-0 · Fax.-42
Internet: <http://www.digitronic.com> · E-Mail: mail@digitronic.com

Notification

This booklet corresponds with the state of the CamCon DC60/61 from June 10th 1996. The company Digitronic Automationsanlagen GmbH has reserved all rights to alterations without prior notice, if these are followed by an improvement of the quality or the functioning of this piece of equipment.

The instruction booklet has been constructed exercising maximum care, but mistakes are not exactly out of the question. We are grateful for any hints concerning possible mistakes in the booklet.

Qualified personal only

Commissioning and operation of the device may only be carried out by qualified personal. Qualified personal are persons, authorized with commissioning, grounding and labeling devices, systems and electrical circuits according to the applicable standards of security

LIABILITY

(1) The salesperson is liable for any damages for which he or the rightful owner is responsible up to the amount of the actual salesprice. Liability concerning missed profits, failed-to-appear savings, indirect damages and consequential damage is excluded.

(2) The liability restrictions above are not valid concerning assured characteristics and damages, which are caused by intention or coarse negligence.

PROTECTION

CamCon DC60/61 and this booklet are protected by copyright. All rights are reserved. Neither CamCon DC60/61 nor this document may be partly or wholly copied, photocopied, reproduced, translated or transferred onto any electrical media or forms which are readable by machine without prior, written permit through the company Digitronic Automationsanlagen GmbH.

Note: The products of Digitronic are so well constructed that they will not be effected by the millenium.

Note: CamCon is a registered trademark of the company Firma Digitronic Automationsanlagen GmbH.

Note: The cam controllers of the CamCon series fulfill the norms regarding electromagnetic emission: EN 55011, EN 55022, EN 55024 Part 2, EN 50082 Part 2, ENV 50140, VDE 0843 Part 2, VDE 0843 Part 4, VDE 0871, VDE 0875 Part 3 ("N"), VDE 0875 Part 11, VDE 0877 Part 2, IEC 801 Part 3, IEC 801 Part 2, IEC 801 Part 4, IEC 801 Part 5.



(c) Copyright 1992 - 2000 / File: DC_L_E.DOC

Digitronic Automationsanlagen GmbH
Auf der Langwies 1
D-65510 Hünstetten - Wallbach
Tel. (+49)6126/9453-0 Fax. (+49)6126/9453-42
Internet: <http://www.digitronic.com>
E-Mail: mail@digitronic.com

Table of contents

1. Introduction	5
2. Principle of function.....	6
3. Mechanical installation instructions.....	7
4. Electrical connections	8
4.1. The encoder	8
4.2. The external program selection	8
4.3. The serial interface.....	8
4.4. The outputs	8
4.5. Precautions to be taken during welding operations.....	9
4.6. The pin allocation of the single axis compact unit	10
5. Multi axis systems	11
5.1. Construction of a dual controller system.....	11
5.2. Construction of a tripple controller system.....	12
5.3. Upgrading multi axis units.....	13
5.4. Ordering the new axis.....	13
5.5. Adjustment of the board to the axis number.....	13
5.6. The option program change	14
5.7. Opening the multi axis device	14
5.8. Wiring of the new axes	15
5.9. Pin allocation in a multi axis system	15
6. The user terminal	17
6.1. Outline of the user terminal	17
6.2. The LED display unit.....	18
6.2.1. The seven-segment display	18
6.2.2. The LED display bar.....	18
6.3. The Liquid Crystal Display (LCD)	18
6.4. The speed and position display	18
6.5. The keyboard	19
6.6. Outline of the key functions	19
7. Commissioning.....	21
8. Programming	21
8.1. General information.....	21
8.2. CamCon main menu	21
8.3. The user key.....	22
8.4. Complete deletion	22
8.5. The system constants.....	23
8.5.1. Language	23
8.5.2. Real encoder resolution	24
8.5.3. Electronic gear and change of the rotation direction	24
8.5.4. Zero point, Offset.....	24
8.5.5. Speed factor.....	25
8.6. Program selection.....	26

8.7. Programming cams	26
8.7.1. Output selection	26
8.7.2. Giving outputs names	26
8.7.3. Input of cams	27
8.7.4. Programming additional cams on an output	27
8.7.5. Cam search	27
8.7.6. Editing cams	27
8.7.7. Optimizing cams	28
8.7.8. The "TEACH IN" function	28
8.7.9. Deletion	28
8.7.9.1. Deletion of a programmed cam	28
8.7.9.2. Deletion of a programmed output (cam track)	29
8.7.9.3. Deletion of a program	29
8.7.10. Exit cam programming	29
8.7.11. Example for cam programming	30
8.7.11.1. First cam programming	30
8.7.11.2. Programming additional cams on an output	31
8.8. Automatic display (output display)	31
8.8.1. Program selection	31
9. Disruptions	32
9.1. I-ERR (Actual position error)	32
9.2. A-ERR (Output error)	32
9.3. CamCon does not save data	32
10. watch doc	33
11. Technical data of the CamCon	34
12. Key word table	35

1. Introduction

Electrical cam switch units have been used successfully by the industry for a long time. The experiences which have been collected in close co-operation during these years have been considered during the development of the CamCon. The result is a compact digital cam switch unit which owns a maximum of user comfort and reliability.

The following characteristics distinguish the CamCon:

- * Experienced and reliable hardware
- * Big seven-segment display for program, position and speed
- * Multi language LC-Display with good contrast 8 lines, 40 characters
- * Front panel with acoustic buttons
- * Compact construction
- * In/Outputs with separate potential
- * Display status of all 32 outputs at the same time
- * As many cams per output as programmable
- * Optimizing of the switching points while the machine operates
- * Digital speed display with programmable factor
- * Integrated electronic gear with free programmable gear factor
- * Optionally upgradable to 64 outputs
- * In steps of 1 ms adjustable compensation of the mechanical dead time of switching devices
- * Voltage supply 24V DC +/- 20%

Cam controllers are being used everywhere where switching procedures are being periodically repeated. Digital cam controllers replace mechanical ones optimally and furthermore offer other advantages, for example:

- * Simplification of assembly and adjustment procedures
- * Reproducible justage
- * Standardization for all possible ranges of operation
- * Reliability

2. Principle of function

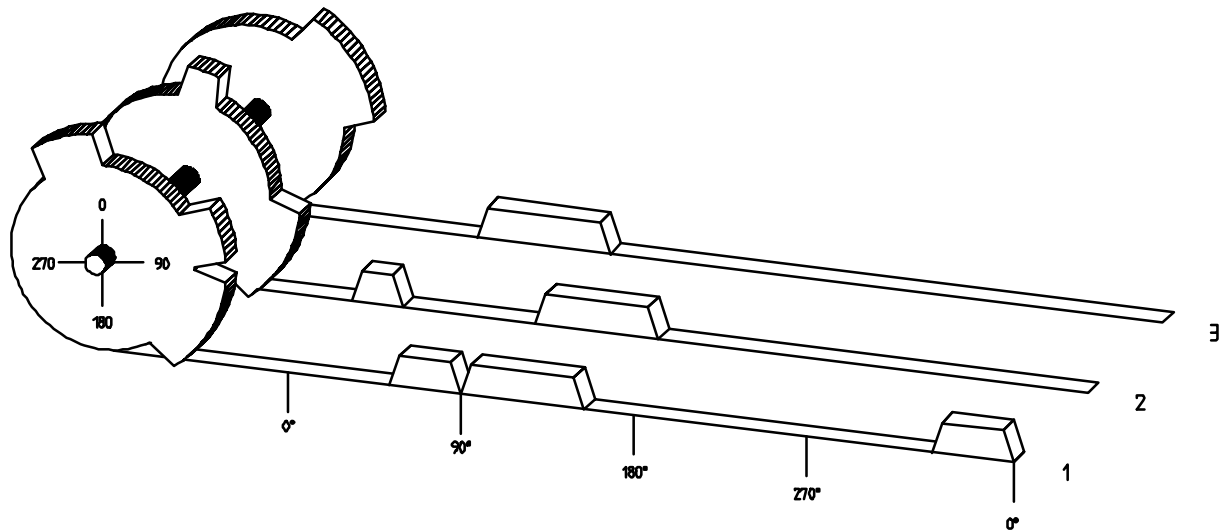

Fig.: Principle of function of a cam controller

For a better understanding of the function of a cam switch unit its principle is presented here. It has 3 outputs containing the following cams:

Output 1	Cam 1: Activation point	60°	Deactivation point	85°
	Cam 2: Activation point	95°	Deactivation point	145°
	Cam 3: Activation point	325°	Deactivation point	355°
Output 2	Cam 1: Activation point	5°	Deactivation point	20°
	Cam 2: Activation point	95°	Deactivation point	145°
Output 3	Cam 1: Activation point	30°	Deactivation point	85°

The 3 as beds presented progressions of the output signals occur, if the 3 cam plates turn anticlockwise past a sensor, which scans the cams on the 0° axis.

The duration of the switching on of a mechanical cam switch unit, i.e. the range between the on and off position, is determined by the length of the cams. The length and the position of the cams can only be limitedly varied, which additionally demands a relatively high mechanical and chronological expenditure. With the CamCon, these adjustments are realized within a fraction of a second, besides the number of the cams per bed is optional. An encoder, which has been connected to the device reports the position to the CamCon. The CamCon compares this with the programmed (de)activation points from all the outputs. If a position appears in a range of a programmed (de)activation point (cams), all affected outputs will be switched.

3. Mechanical installation instructions

To incase the front plate, the CamCon is inserted into an opening (as shown in the drawing).

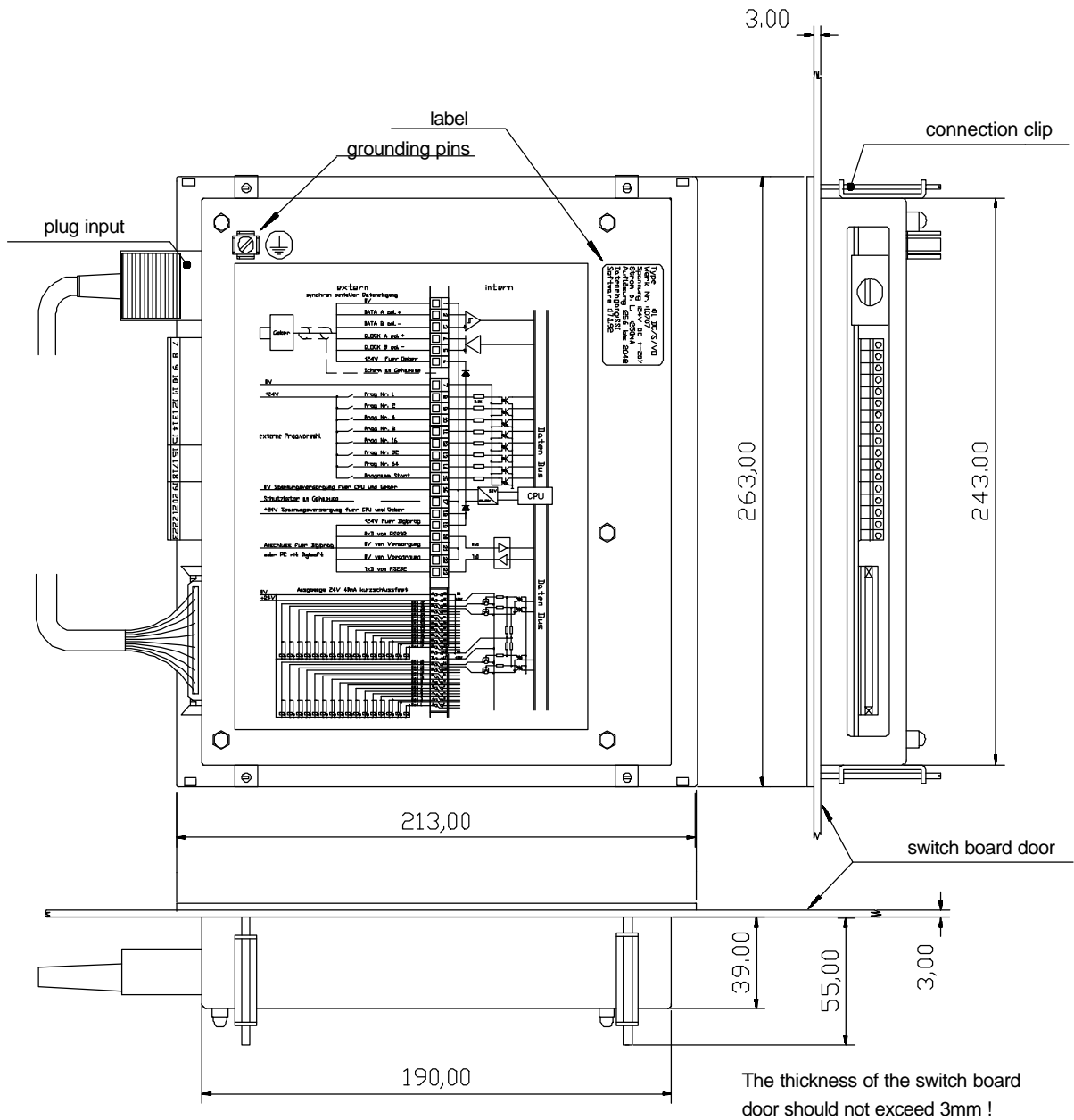

CUTOUT PER DIN 192mm⁺¹ X 245mm⁺¹

- connect no more than one wire to each pin
- do not allocate voltage to the outputs
- connect the grounding pin on the back of the Camcon with the switch board encasement
- connect all mantled cables (cable of the encoder, the voltage supply or the outputs) in the form of a star
- make all cable connections in a cold state
- lead controlling wires to the CamCon separat from power current lines
- never enter or remove a plug under current

- operate only under the VDE regulations
- clean foil keyboard only without plug with water or spiritus
- do not damage foil keyboard with sharp or edged objects
- work only according to antistatic regulations
- watch CamCon during assembly to prevent overheating
- maximum temperature of the operation environment is 55°C
- cold state storing temperature: -15°C to +75°C
- maximum humidity 85%

4. Electrical connections

To prevent disruptions, use separate power supplies for CPU /control unit and the outputs. The grounding clip of CamCon has to be connected at the grounding point of the encasement.

4.1. The encoder

The voltage supply of the encoder is internally connected to the voltage supply of the outputs. If the supply voltage is connected to the outputs, the encoder is also supplied. The data transfer from the encoder to the CamCon takes place through a bidirectional RS422 interface. The data protocol corresponds with the Stegmann SSI Norm.



Attention: *It is not allowed to plug the encoder into the CamCon while voltage is connected, because the encoder runs with 24V, the data connection with 5V!*

4.2. The external program selection

It is possible to change the programs of CamCon via external inputs. The program number has to be connected on the inputs in a binary code. Then a pulse with a minimal length of 20ms at the program start input changes the program in the CamCon online.

Using CamCon with an SSI data input, it is possible to select all 128 programs.

4.3. The serial interface

The serial port is for connecting the CamCon to an external PC for changing datas or programming the CamCon with a communication software (for example DIGISOFT). It is also available to store CamCon programs on PCs hard disk.

Multi controller systems use the serial port to connect all the systems.

4.4. The outputs

The outputs are short circuit proof. If all outputs are switched on, you may only extract up to 40mA per output in full temperature range, or the device switches off with an error message. If you need a higher output power, you should know that the outputs 1, 3, 5 etc. up to 15, the outputs 2, 4, 6, etc up to 16, the outputs 17,19,21 etc up to 31 and the outputs 16, 18, 20 etc up to 32 form groups. Within this 4 groups 360mA permanent current are available at 50°C of surrounding temperature, at 25°C of surrounding temperature it increases to 500mA of permanent current. This output current can be distributed as desired within a group, as long as the output current of a single output does not exceed 300mA.



Attention: *With inductive loads the outputs have to be switched with free wheeling diodes.*

4.5. Precautions to be taken during welding operations



Attention: *For the duration of welding operations carried out at the machine, the connecting wires concerning the data exchange from the measuring system to the CamCon and the power supply as well as the grounding connections and inputs and outputs have to be separated from the CamCon.*

4.6. The pin allocation of the single axis compact unit

Pin	1:	0V for encoder
Pin	2:	Data A or +
Pin	3:	Data B or -
Pin	4:	Clock A or +
Pin	5:	Clock B or -
Pin	6:	+24V DC for encoder
Pin	7:	0V supply
Pin	8:	Prog.-No. 1
Pin	9:	Prog.-No. 2
Pin	10:	Prog.-No. 4
Pin	11:	Prog.-No. 8
Pin	12:	Prog.-No.16
Pin	13:	Prog.-No.32
Pin	14:	Prog.-No.64
Pin	15:	Program start
Pin	16:	0V voltage supply for CPU and encoder
Pin	17:	0V voltage supply for CPU and encoder
Pin	18:	+24V DC 0V voltage supply for CPU and encoder
Pin	19:	+24V DC for DIGIPROG or DIGITERM
Pin	20:	RxD from RS232
Pin	21:	0V from supply
Pin	22:	0V from supply
Pin	23:	TxD from RS232

The outputs are connected on a 40 poled plug and have the following allocation:

Pin 1 - Output	2	Pin 11 - Output	12	Pin 21 - Output	18	Pin 31 - Output	28
Pin 2 - Output	1	Pin 12 - Output	11	Pin 22 - Output	17	Pin 32 - Output	27
Pin 3 - Output	4	Pin 13 - Output	14	Pin 23 - Output	20	Pin 33 - Output	30
Pin 4 - Output	3	Pin 14 - Output	13	Pin 24 - Output	19	Pin 34 - Output	29
Pin 5 - Output	6	Pin 15 - Output	16	Pin 25 - Output	22	Pin 35 - Output	32
Pin 6 - Output	5	Pin 16 - Output	15	Pin 26 - Output	21	Pin 36 - Output	31
Pin 7 - Output	8	Pin 17 -	+24V	Pin 27 - Output	24	Pin 37 -	+24V
Pin 8 - Output	7	Pin 18 -	+24V	Pin 28 - Output	23	Pin 38 -	+24V
Pin 9 - Output	10	Pin 19 -	0V	Pin 29 - Output	26	Pin 39 -	0V
Pin 10 - Output	9	Pin 20 -	0V	Pin 30 - Output	25	Pin 40 -	0V

5. Multi axis systems

It is possible to realize a multi controller sytem with 64 single devices. This network has the following advantages:

- * programming with only one programming terminal
- * low costs for one single device
- * easy handling
- * small housings

The programming have to be done separate for each system.

The pictures shows you the construction of a dual controller system and a tripple controller system, with the possibility to use on each single system one encoder. The wiring of the serial port is completely ready and have not to be changed. While fixing-up it is nessecary to note the dimensions of the device.

5.1. Construction of a dual controller system

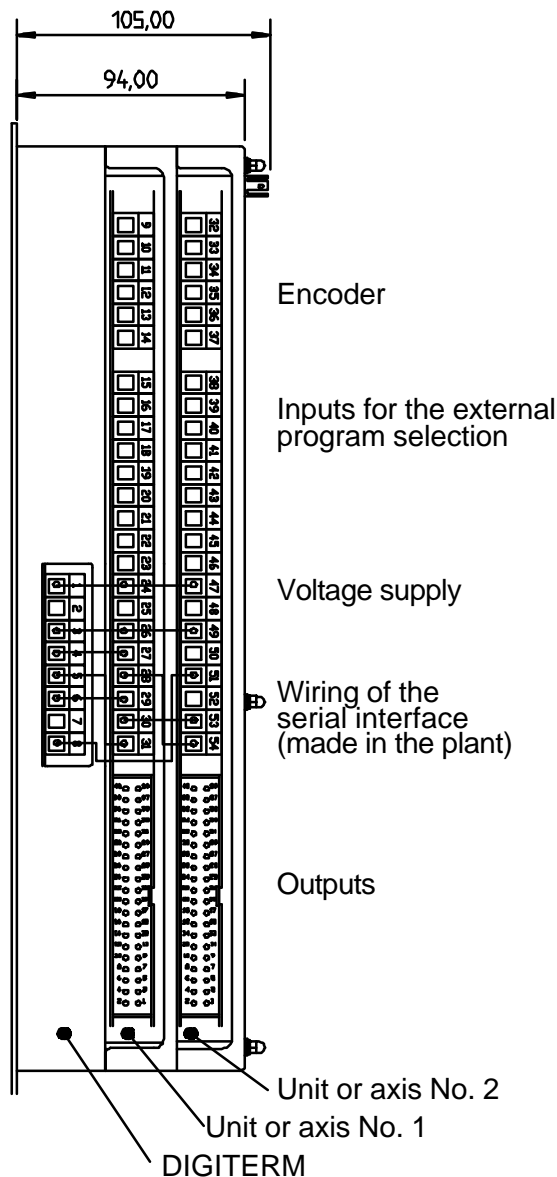

5.2. Construction of a tripple controller system

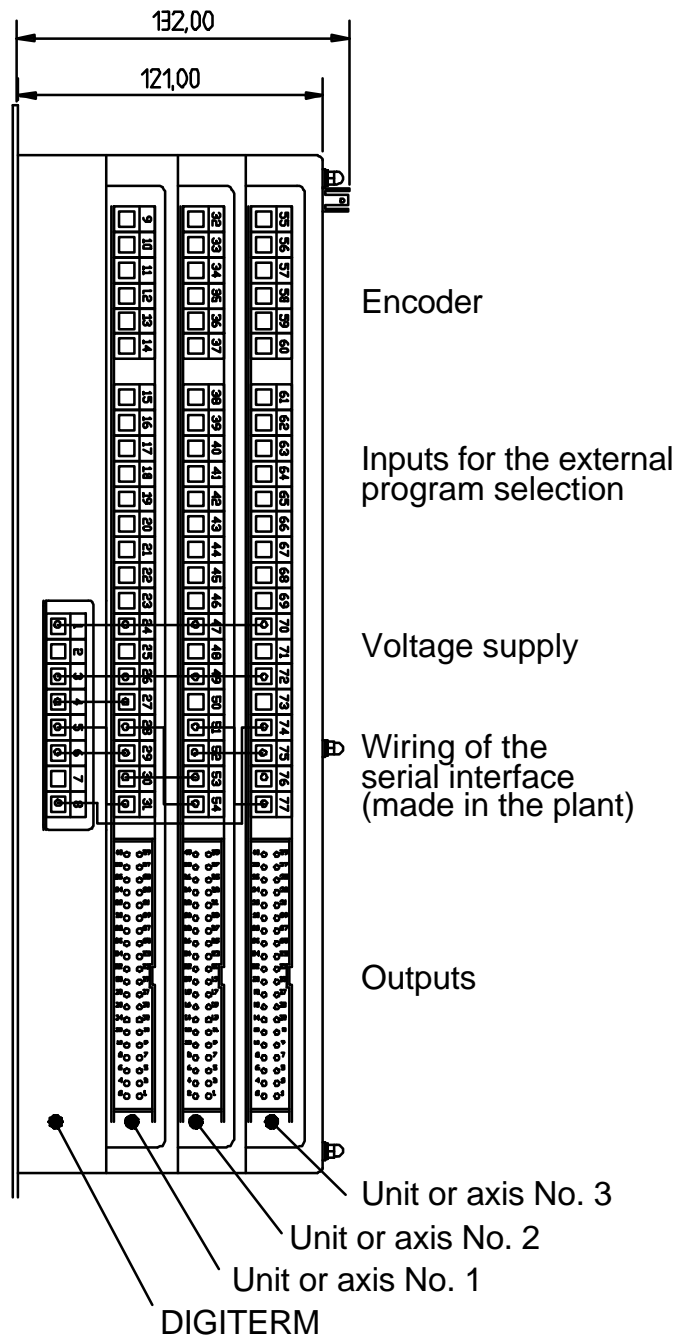

If more than 3 systems are used, calculate 27mm distance for each next system.

5.3. Upgrading multi axis units

To upgrade a multi axis unit from 1 axis to 2, 3 or 4 axis , you have to follow the next procedure.

5.4. Ordering the new axis

The order discription is as follows: "DC71 / Type / Axis number"

Example: "**DC71 / I / 3**"

The single parameters of the discription example have the following functions:

- DC** - CamCon
- 71** - New axis (for upgrading)
- /I** - Incremental data input
- /3** - Axis number 3

You have to specify the type of board and the number of the axis (see order discription). This information is used to label the pins and set the unit number.

Also part of the equipment are:

- the board
- labels for the pin numbers (if no axis number is specified, the pins are not labeled in the plant)
- the additional encasement ring
- 5 spacing bolts M4 x 25mm

5.5. Adjustment of the board to the axis number

On the boards of the CamCon 61/71 series are DIP switches with 8 poles or 8-segment soldering bridges to set the number of the axis. The first axis in the device bears the number 1, the second axis the number 2 and so on. **You may not assign the same number to several axis on the same board !!!** By connecting the axis modules via the serial interface and the setting of the unit number, the programming device for the multi axis system (DIGITERM/DIGIPROG) can differentiate between the different axis.

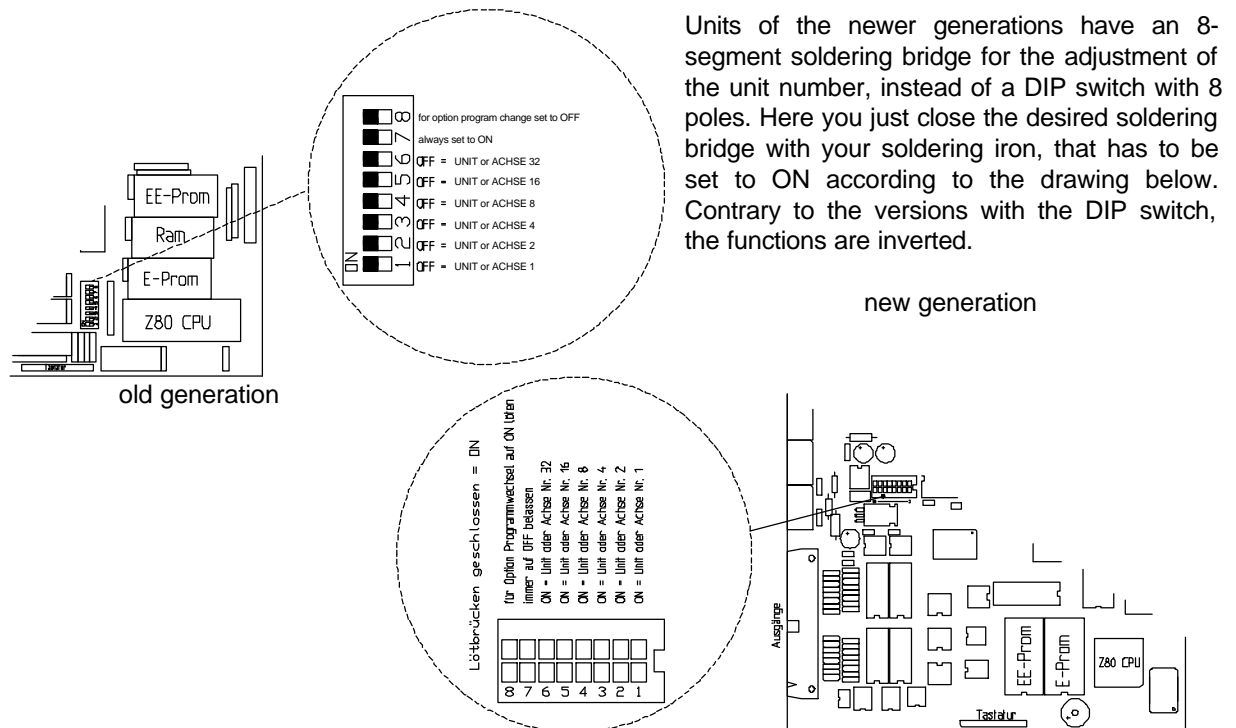

5.6. The option program change

CamCons 61/71 with 2 or more axes have the ability to change the programs of all axes simultaneously. This is done with DIP switch No. 8 (or soldering bridge segment No. 8). If it is set to OFF (ON for a soldering bridge segment), the program of this axis is changed, when the program of another axis is changed via the keyboard.

This option is only available, if all components of the CamCon 61/71 are equipped with software from at least February 5th 1993 !

If the communication via the serial interface was not possible, the unit displays "P-ERR" after one second, and the axis goes into the error mode (all outputs switched off).

5.7. Opening the multi axis device

- remove all plugs from the device
- open the lid by unscrewing the top nuts
- remove the upper spacing bolts (M4 x 24 mm)
- fasten the new bolts (M4 x 25 mm) lightly
- insert the new board
- insert the new device ring
- to install another axis, repeat the installation procedures above
- now fasten the old spacing bolts (M4 x 24 mm) again
- put the lid back on and secure it again with screws, notch plates and nuts.

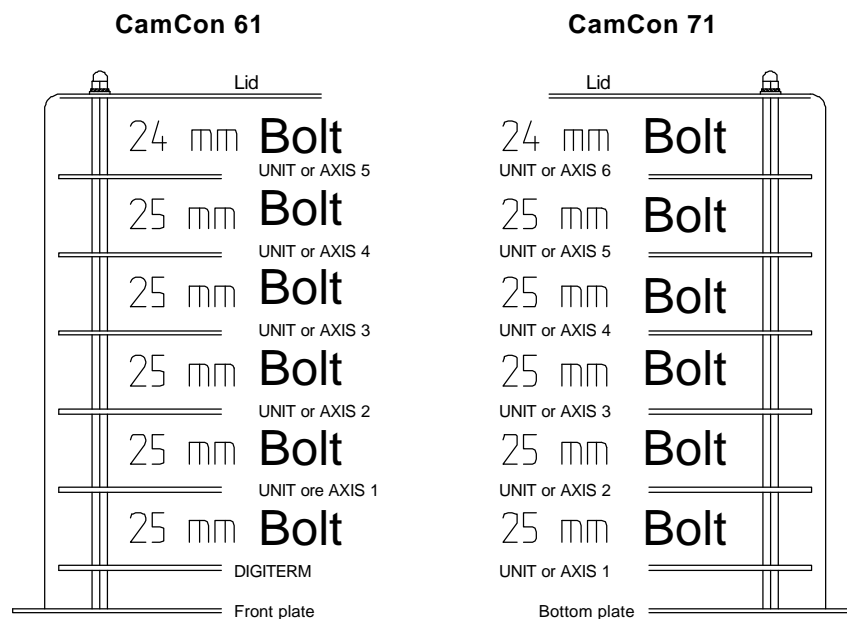

5.8. Wiring of the new axes

Plug in the PINs with continued numbers in the CamCon. Wiring have to be done as shown in the following picture. If there used less than 6 systems, the wire from PIN 143 must be disconnected and must be new connected as followed:

- at 5 Systems => PIN 120
- at 4 Systems => PIN 97
- at 3 Systems => PIN 74
- at 2 Systems => PIN 51
- at 1 System => PIN 28

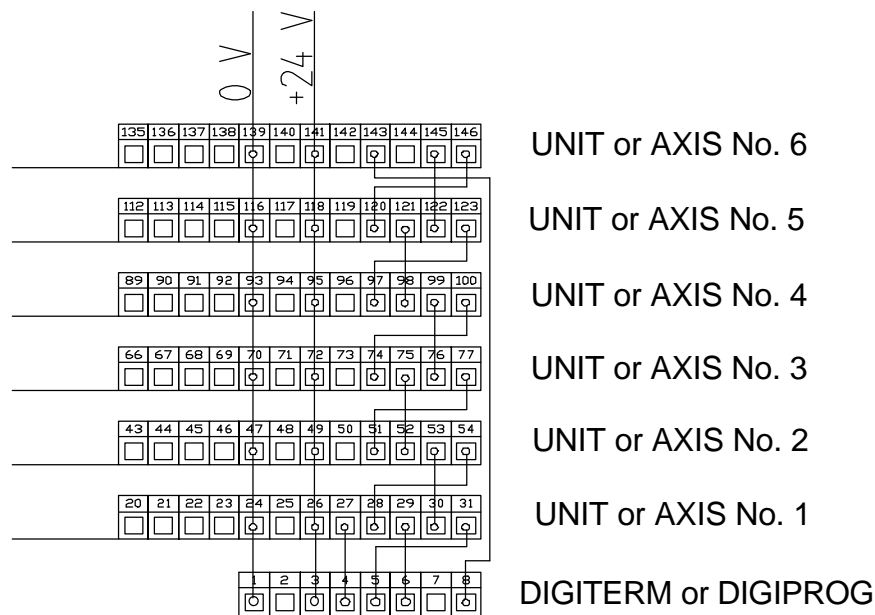

5.9. Pin allocation in a multi axis system

The values in () are for units or axes 2,3,4...

Pin	1:	0V supply
Pin	2:	0V supply
Pin	3:	+24V DC supply
Pin	4:	+24V DC supply
Pin	5:	RxD data receive pin of the RS232
Pin	6:	0V from supply
Pin	7:	0V from supply
Pin	8:	TxD Data send pin of the RS232
Pin	9 (32,55,78...):	0V for encoder
Pin	10 (33,56,79...):	Data A or +
Pin	11 (34,57,80...):	Data B or -
Pin	12 (35,58,81...):	Clock A or +
Pin	13 (36,59,82...):	Clock B or -
Pin	14 (37,60,83...):	+24V DC for encoder

Pin	15	(38,61,84...):	0V supply	
Pin	16	(39,62,85...):	Prog.-No.	1
Pin	17	(40,63,86...):	Prog.- No.	2
Pin	18	(41,64,87...):	Prog.- No.	4
Pin	19	(42,65,88...):	Prog.-No.	8
Pin	20	(43,66,89...):	Prog.-No.	16
Pin	21	(44,67,90...):	Prog.-No.	32
Pin	22	(45,68,91...):	Prog.-No.	64
Pin	23	(46,69,92...):	Program start	
Pin	24	(47,70,93...):	0V voltage supply for CPU and encoder	
Pin	25	(48,71,94...):	0V voltage supply for CPU and encoder	
Pin	26	(49,72,95...):	+24V DC voltage supply for CPU and encoder	
Pin	27	(50,73,96...):	+24V DC for DIGIPROG	
Pin	28	(51,74,97...):	RxD from RS232	
Pin	29	(52,75,98...):	0V from supply	
Pin	30	(53,76,99...):	0V from supply	
Pin	31	(54,77,100...):	TxD from RS232	

The outputs are connected on a plug with 40 poles and have the following allocation:

Pin 1 - Output	2	Pin 11 - Output	12	Pin 21 - Output	18	Pin 31 - Output	28
Pin 2 - Output	1	Pin 12 - Output	11	Pin 22 - Output	17	Pin 32 - Output	27
Pin 3 - Output	4	Pin 13 - Output	14	Pin 23 - Output	20	Pin 33 - Output	30
Pin 4 - Output	3	Pin 14 - Output	13	Pin 24 - Output	19	Pin 34 - Output	29
Pin 5 - Output	6	Pin 15 - Output	16	Pin 25 - Output	22	Pin 35 - Output	32
Pin 6 - Output	5	Pin 16 - Output	15	Pin 26 - Output	21	Pin 36 - Output	31
Pin 7 - Output	8	Pin 17 -	+24V	Pin 27 - Output	24	Pin 37 -	+24V
Pin 8 - Output	7	Pin 18 -	+24V	Pin 28 - Output	23	Pin 38 -	+24V
Pin 9 - Output	10	Pin 19 -	0V	Pin 29 - Output	26	Pin 39 -	0V
Pin 10 - Output	9	Pin 20 -	0V	Pin 30 - Output	25	Pin 40 -	0V

6. The user terminal

6.1. Outline of the user terminal

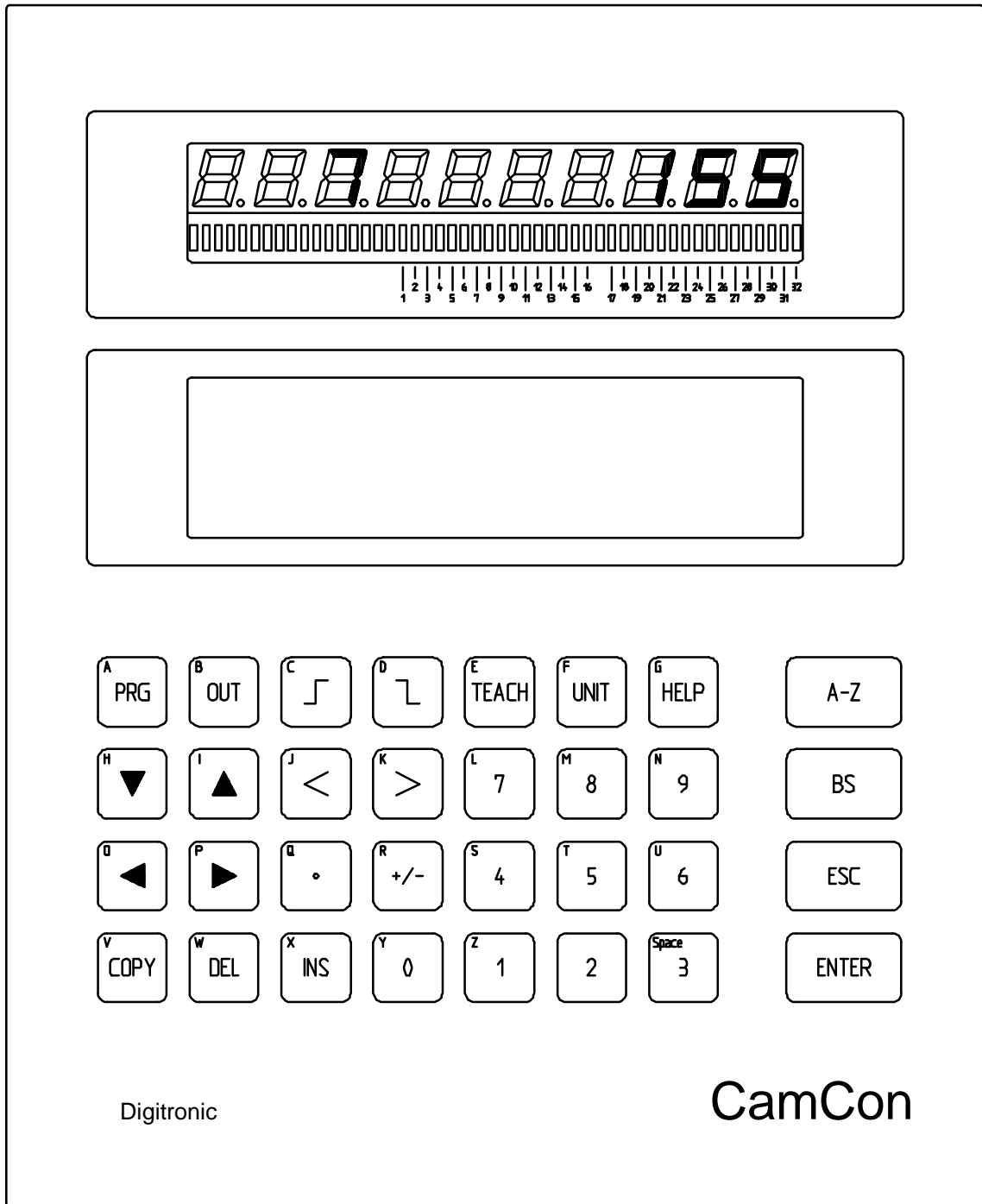

6.2. The LED display unit

6.2.1. The seven-segment display





The CamCon LED display with 10 big digits (13mm) guarantees a good view to the values from a few meters distance. On the right side the speed or the position of the encoder is readable, on the left side the actual program number.

6.2.2. The LED display bar

Under the LED 7-segment display there is a LED display bar, where the user can read the status of all outputs on the same time.

6.3. The Liquid Crystal Display (LCD)

Under the LED-Display unit there is a LC-Text Display with 8 lines x 40 characters.

The contrast of the LCD can be adjusted with the keys  and . Via the keys  and  you can set the basic parameters of the contrast.



Attention: *With multi axis systems, you can only adjust the contrast after having pressed the  key.*



The top line of the LC-display displays the status of the CamCon:

"Unit" = unit number (multi axis system)
"Prg" = program number (0-127)
"Speed" = speed with rotation direction
"Act" = current position of the machine

In the second line the selected menus are displayed, on the right side a possible error-message is shown.

6.4. The speed and position display

On the LC-Display the program number, the speed and the actual position are displayed at the same time. If you are in "main menu" or in the "automatic menu", speed and current position are displayed in upper righthand corner of the LCD. The 7-segment display then shows the speed and program number. If you select the menu points "2 Programming", "3 Operating parameters" or "4 Dead Time Compensation", the 7-segment display automatically switches to the position display.

With Multi-controller systems the change between the displays (speed to position) is possible by pressing the , followed by the  key. By pressing the two keys at once, you return to the speed display.

6.5. The keyboard

The plastic foil keyboard is the most important functioning group of the front plate of the CamCon. All adjustable functions are set via keyboard. It consists of an alphabetic key block as well as different function keys.

The keyboard is non-sensitive towards dirt and is solvent resisting. The keys have a noticeable action point for the tactile feedback, as well as an acoustic input acknowledgement.

6.6. Outline of the key functions



key for selecting a desired program



this key has no function at this time



input for additional cams on the outputs / cam tracks

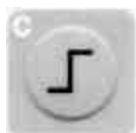

you enter the activation point of a cam with this key



you enter the deactivation point of a cam with this key



By pressing this key, you can initiate the following functions in a multi axis system: input of unit (axis) numbers, change the 7-segment display from "Speed" and "Prg" to "Position" and adjust the contrast setting of the LCD.



Cursor movement downwards (selecting the next menu point) or contrast adjustment of the LCD



Cursor movement upwards (selecting the previous menu point) or contrast adjustment of the LCD



Cursor movement to the left (selecting the previous menu point) or basic adjustment of the contrast



Cursor movement to the right (selecting the next menu point) or basic adjustment of the contrast



lowers input values



raises input values



ASCII-Character, no decimal point!



changes the algebraic signs



this key has no function at this time



delete cams and single outputs



help function is not implemented yet



confirm key



breaks off functions and leaves the current menus, to return to the next highest menu



deletes any previously entered character



You can use this key to label your cams. When this key is pressed the small letters on the upper lefthand corner of the small keys become active.

7. Commissioning

Before activating the unit for the first time, please check the wiring of the device. (see chapter "Pin allocation").



Attention: *With induced loads the outputs have to be switched with a freewheeling diode. Covers or inductivities very close to the device inside the switchboard have to be switched with a deletion unit as do those that are wired to or influence the wiring of the device.*

After being switched on the CamCon will generate a short tone. After a successful installation of the system, the standard display (the current program number, the position and the speed, as well as a possible error message) is displayed. Once the system registers are brought in accord to the measuring system and it is wired correctly, there should be no further error messages.

8. Programming

8.1. General information

The programming of the CamCon happens 'online', meaning that all changes made by you are in the programming menus are carried over into the RAM memory after being confirmed and thus directly influence the switching processes.



Attention: *If you do not leave a menu point after having made and confirmed an input of parameters, the new settings have not been written into the longterm memory (EEPROM), but still is only in the RAM memory. If the supply voltage is disrupted, the programming is lost. Only when you leave the menu point by pressing the key, the new parameters are secured into the longterm memory.*

8.2. CamCon main menu

After having connected the supply voltage, the CamCon automatically switches to its main menu displayed below.

```
Unit: 1 Prg: 0 Speed: 0 Act: 94
CAMCON MAIN MENU
1 Automatic Display
2 Programming Operation
3 System Constants
Your Choice:
```

The upper line displays the status:

Unit = unit number (multi axis system)
Prg = program number (0-127)
Speed = speed with rotation direction
Act = current position of the machine

8.3. The user key

Before setting up the CamCon, a user key must be given in. For this action, the following menu displays:

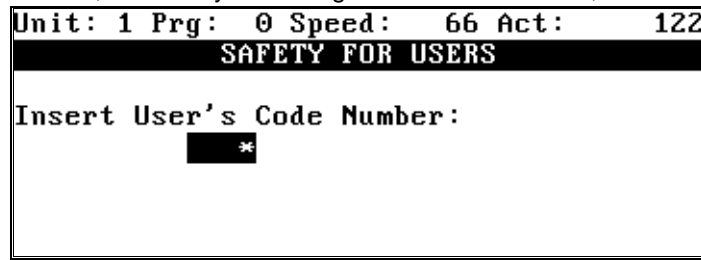

There are 2 valid key codes:

1. the supervisor code "5693"
2. the user code "5471"





The supervisor code allows you to change any parameter of the device, while people with the user code have no access to outputs 1 to 8. This protects you from changes of specific output parameters that usually remain constant. Also the user is not able to change or define a key code.

8.4. Complete deletion

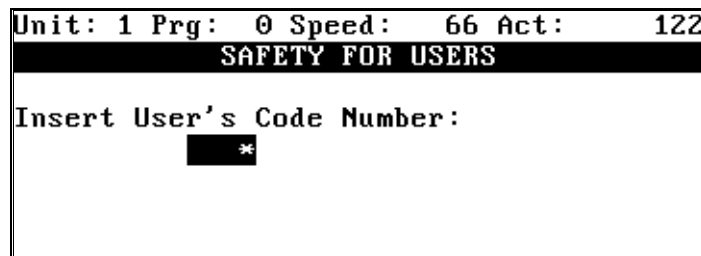

After first switching on the supply voltage the program memory is not in a defined state. So when first using the CamCon unit you have to put a complete deletion into operation as follows:

1. Select the main menu point "System Constants" (key ). The following menu is displayed:



2. Enter the user key "5693".
3. Confirm with the  key.
4. Press the  key.
5. Press the  key.
6. Press the  key.

Implement the following steps, if using a multi axis system:

7. Press the  key.
8. Press the  key.
9. Press the  key.

The display shows the following:





Attention: *It is not possible to cancel or leave the complete deletion at this point.*

By pressing the  key, the entire memory is deleted and reinitialized, and the program automatically changes back to the main menu.

8.5. The system constants

To make your device operable, you have to set a minimum number of parameters on your CamCon. This is the recommended order of the parameterization. You can find the necessary information in the corresponding chapters.

To set these parameters, select the menu point "Operating parameters" in the main menu by pressing the  key, and enter the user code "5693". Confirm your input with the  key, and the operating parameter menu appears on the display:

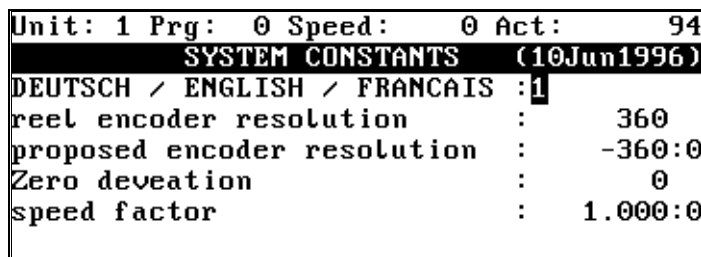





8.5.1. Language

After you are in the system parameter menu, the cursor stands on the menu point \hat{o} language \ddot{o} for select the language.

CamCon gives you the possibility to change between German, English and French.

For your selection you have to push the buttons:

- Key  = German
- Key  = English
- Key  = French

With the key  or the  key, you confirm your input. The value is written into the memory. Because of this - if you selected a new language - the menu is displayed in the new language after having confirmed the change.

The cursor then moves to the next menu point "Real encoder resolution".

8.5.2. Real encoder resolution

In this point the user have to input the physical resolution of the encoder. Please note, that the value must be the count of steps for all turns. With the use of an encoder with a resolution of 4096 steps per revolution and 4096 turns, you have to enter the corresponding resolution values of 16 777 216 in the input fields "Real encoder resolution"

The input is confirmed by pressing , and the next menu point is automatically selected.

8.5.3. Electronic gear and change of the rotation direction

Here you can enter the ratio of the effective encoder measurement (electronic gear), with which you calculate and which is shown on the display. The size of this value can be a maximum of 10 * the real encoder resolution. By pressing the key you can implement a change of the rotation direction via the software. Between the algebraic sign for the rotation direction and the rotation of the encoder there is the following connection:

Rotating the engine wave of the encoder clockwise means:

- positive value (without algebraic sign) = steps in increasing order
- negative value (with negative algebraic sign) = steps in decreasing order

The digit after the ":" shows the number of spaces after the comma for the display. Press the key to enter the input of the spaces after the comma. Enter a digit for the number of the decimal spaces (e.g. "1" => Display **0.0** , "2" => Display **0.00** , and so on). You close the input of this menu point by pressing .

Example: At a full rotation of a rotation encoder with 360 steps per rotation a machine proceeds for 1000mm.

If the display of the position is to be shown in mm rather than in angular lines, you have reset the gear with the factor **1000:0**. The display will no longer change in single steps, since the resolution remains unaffected.

If you choose e.g. **1000:1**, the actual position is calculated down to a proceeding range of 100. The position display measure is in cm, and a digit after the comma shows the millimeters

The input of the desired encoder resolution is a measurement area transformation.

8.5.4. Zero point, Offset

When you make adjustments to the CamCon, it can happen that the mechanical zero point does not match the CamCon's electronic zero point. This zero point can be adjusted with the input of a correction value.

The upper righthand corner of the LCD displays the physical position of the encoder. First calibrate the device to its physical zero point . If the value of the zero point offset menu point is anything other than "0", you have to enter the value "0". The position display in the LCD now shows the offset between the mechanical and the elektronical zero point.

If this value is set to "0", you do not have to make a correction. To adjust the CamCon, you just have to enter the displayed position at the input field of the zero point offset. After the key is pressed the position value on the LCD and the seven-segment display change to "0"; the cursor moves to the next menu point.

8.5.5. Speed factor

The CamCon determines the speed in steps per second. This number is displayed by the seven-segment display (in the main menu and in the automatic menu). To adjust the speed display to other measurements (e.g. rotations/min, pieces/h or m/min.) you can enter a randomizing factor in this input field.

Example:

With an encoder with 360 steps per rotation the CamCon displays at 1 rotation/minute: 6 steps per second. To have the CamCon display the value in rotations/minute you have to enter 1/6 of the value displayed at the speed factor input field.

The calculation for one rotation/minute is done according to the following formula:



$$\text{Speed factor} = \frac{60}{\text{desired encoder resolution}}$$

By pressing the key you exit this menu point automatically, and the cursor moves to the input field for the numbers after the comma. Here you enter a value for the number of digits you want displayed after the comma (e.g. "1" => Factor x 0.1 , "2" => Factor x 0.01 , and so on). Pressing closes the input of this menu point, and the cursor moves to the next one.

8.6. Program selection



Before you can begin with the programming of a cam, you have to select a program number under which you want to do your programming. This program number is selected under the menu point "Automatic display" and is displayed in the first line of the LCD.

Procedure:

1. Press the  key.
2. Enter the user key code "5693".
3. Select the program number wählen (e.g. 1).
4. Confirm your input with the  key.
5. Leave the menu "Automatic display" by pressing the key .



The selected program number is already shown on the LCD and the seven-segment display.

8.7. Programming cams

By pressing the  key in the main menu, you reach the "Programming mode" (see drawing below), after having entered the user key code "5693" and having pressed the  key to confirm it.

Unit: 1 Prg: 0 Speed: 62 Act: 84			
output	name	217 on	off
1	Automatic cam	12	45
2	Speed cam	123	35
3	<	180	210
4		35	321>
5	no	cam	
6	no	cam	

8.7.1. Output selection







Select the first output, on which you want to program the first cam, by pressing the keys  and . You can select the output directly with an input of the output number (e.g. 5).

8.7.2. Giving outputs names





You can assign an individual label (e.g. "VACUUM ON" or "PUMP OFF")

This function is only possible in programming mode "2" after an input of the user key "5693".

Example:

1. Press the key .
2. Press the key . The input field behind the output number is show inverted.
3. By pressing keys  to , you can enter a desired text. The special characters "." and the numbers "0" to "9" are available by a repeated pressing of the  key verfügbar. A wrong input of a character can be deleted with the  key. Press the  key, and the text is written into the memory.



8.7.3. Input of cams

When you have defined the desired output, press the key  to initiate the programming sequence of the cam. Now you can enter the activation point of the cam with the numeric keys. When this value is set, move to the input of the deactivation point of the cam with the  or the  key. Confirm your input with the  key. This ends the cam input, and the output is switched accordingly.









Attention: *If you do not exit the programming mode "2" after input of a cam, the value of the cam is not stored in the longterm memory (EEPROM), but is still in the RAM. A disruption of the supply voltage will cause a loss of this data. Only upon leaving the programming mode by pressing the  key, the newly programmed data is written into the EEPROM and become save.*

8.7.4. Programming additional cams on an output



To program additional cams on the same output, press the  key in the programming mode. The message "new" appears in the middle of the two input fields. The input field for the new activation point is inverted. After the input of a number (e.g. 100) and pressing the  key, you can set the new activation point (e.g. 150). The input of the new deactivation point is analog to this one.

Example:



1. Press the  key (in the main menu)
2. Enter the user key, and confirm it by pressing the  key.
3. Press the  key.
4. Select the output.
5. Enter the desired activation point for the new cam (e.g. 100).
6. Press the  key.
7. Enter the desired deactivation point for the new cam (e.g. 150).
8. Write the new values into the EEPROM memory with the  key.

Cams that overlap result in a new, larger cam. The cams can be set over zero (e.g. 330 to 30). After the programming the display shows the signs "<" and/or ">", meaning that additional cams have been programmed on this output. By pressing the keys  and , you can view the different cams on this output that are above or below the cam you are currently viewing.



8.7.5. Cam search

You can display all programmed cams on an output by pressing the keys  and .

8.7.6. Editing cams







You can change a previously programmed cam. Just press the  or the  key to select the (de)activation point, and enter a new value. By confirming the change with the  key, you store the new cam into the memory.

8.7.7. Optimizing cams

During the input of the (de)activation point of a cam, you can in- or decrease the input values in steps of one with keys  and . These new values are written into the memory directly and automatically. With this option, the CamCon offers the user the ability to optimally adjust the unit to any switching process, even while the machine operates.

8.7.8. The "TEACH IN" function

In programming mode "2" you also have the possibility to accept a manually selected position as a (de)activation point, simply by pressing the  key. You proceed as follows:









1. Press the  key. The input field for the activation point is inverted.
2. Press the  key. Put machine into activation position.
3. Press the  key. The current position of the machine is taken as the new value in the input field.
4. Press the  key. The input field of the deactivation point is inverted.
5. Press the  key. Put machine into deactivation position.
6. Press the  key. The current position of the machine is taken as the new value in the input field.

Press the  key again, and the cam is written into memory. The old cam is deleted.

8.7.9. Deletion



8.7.9.1. Deletion of a programmed cam

Select the main menu point "**2 Programming**", and enter your user key. In this menu you can delete previously programmed cams. Follows this next procedure:

1. Select the output with the cam you wish to delete on it with keys  and .
2. Use the  key or the  key to select the cam that is to be deleted.
3. Press the  key. The selected input field is inverted. Delete this value by pressing the .
4. Confirm the deletion with the  key, and the input field of the deactivation point is automatically selected and can also be deleted by pressing the  key.
5. Confirm the deletion by pressing the  key to fully delete the cam out of the memory.





8.7.9.2. Deletion of a programmed output (cam track)

Select the main menu point "**2 Programming**", and enter your user key. In this menu you can delete previously programmed outputs:

1. Use keys  and  to select the output you wish to delete.
2. Press the  key. The output is deleted. After the selected output number the display shows the message "**no cam**" in the input field.

8.7.9.3. Deletion of a program

Select the main menu point "**2 Programming**", and enter your user key. In this menu you can delete whole programs:

1. Press the  key.
2. Enter the desired program number (e.g. 5).
3. Press the  key. The program is loaded.
4. Press the  key.
5. Press the  key. The program is automatically deleted.



Attention: *Before deleting a cam, an output or a program, please check, if you selected the correct program, because once deleted, the data cannot be restored. !*

8.7.10. Exit cam programming

By pressing the  you can leave the programming mode at any time; you then return to the main menu.

8.7.11. Example for cam programming

8.7.11.1. First cam programming

Task:

After a complete deletion of the memory and a correct adjustment of the system parameters, you are to program a cam for output 4 ranging from 100° to 200°.

Solution:

1. Select the main menu point "**2 Programming**"
2. Enter your user code and press the key. You enter the programming menu.
3. Select output 4 with the key or press key and confirm with the key.
4. Press the key to enter the cam activation point; the cursor moves to the input field for the cam activation point.
5. Enter the value "**100**" for the cam activation point with the numeric keys.
6. Confirm your input with the key or press the key directly; the cursor moves to the input field for the cam deactivation point.
7. Enter the value "**200**" for the cam activation point with the numeric keys.
8. Confirm your input with the key, and the new values are written into memory. Your first cam is programmed and ready.
9. Press the key to leave the menu at any time.

8.7.11.2. Programming additional cams on an output

Task:

Program an additional cam in program 0 on output 4. The new cam has a range from 300° to 330°.

Solution:

1. Select the main menu point "2 Programming"
2. Enter your user code and press the key. You enter the programming menu.
3. Select output 4 with the key or press key and confirm with the key.
4. Press the key to enter the cam activation point for the additional cam; the cursor automatically moves to the input field of the cam activation point. The message "new" appears between the two input fields.
5. Enter the value "300" for the cam activation point with the numeric keys.
6. Press the key or the key, and the cursor moves to the input field for the cam deactivation point.
7. Enter the value "330" for the cam deactivation point
8. Press the key to confirm your input. The values are written into memory, and the second cam is finished.
9. Press the key to leave the menu at any time.

The display now shows the newly programmed cam, as well as the symbol "<", that indicated the previously programmed cam between 100° and 200°.

8.8. Automatic display (output display)

By pressing the key in the main menu, you enter the menu "Automatic display". The states of all available outputs are displayed in 4 lines and 2 rows. If an 'M' is displayed after the output, this output is active. If "_" is displayed behind the output, it is not active (see figure).

Unit: 1	Prg: 0	Speed: 62	Act: 286
OUTPUT DISPLAY			
Outputs	1- 8	9-16:	M M _____
Outputs	17-24	25-32:	_____
Outputs	33-40	41-48:	_____
Outputs	49-56	57-64:	_____
Output Macro Display			v
1 Automatic cam			_____

8.8.1. Program selection

If you want to change the program, you can change the program number in the menu point "Automatic display" (e.g. product change).

1. Press the key.
2. Enter the user key "5693".
3. Select the program number (e.g. 1)
4. Confirm your choice by pressing .
5. Exit the menu "Automatic display" with the key.

The new program number is automatically shown on the seven-segment display and the LCD.

9. Disruptions

9.1. I-ERR (Actual position error)

This message is displayed in the second line in the LCD. The following errors possible:

1. Connection cables between the encoder and the CamCon are separated or do not work.
2. Encoder does not operate correctly.
3. The system parameters were not adjusted correctly to the encoder.
4. Cables between CamCon and the encoder lie near disrupting sources (e.g. power current lines).

Solutions:

1. Check the wiring between CamCon and the encoder.
2. Exchange the encoder.
3. Check the system parameters in menu "3". Look for the correct resolution of the encoder, if necessary, change the system parameters.
4. Check the wiring for routes near strong sources of disruption (avoid routes along power current lines).

By pressing the  key, CamCon will try to establish a new contact.

9.2. A-ERR (Output error)

When this message appears on the second line of the LCD, the following errors are possible:

1. The outputs are overloaded (see chapter The outputs).
2. Connected relais have no free wheeling diode. This mkes them incompatible to the CamCon (and might destroy the outputs).

Solutions:

1. Check the allowed total current of all outputs and change the charge, if necessary.
2. Exchange the relais with relais that have a free wheeling diode.

By pressing the  key, CamCon will try to establish a new contact.

9.3. CamCon does not save data

Error: CamCon does not store the programmed data (menu "2", "3", "4").

Cause: 1. Before you left the programming menu with the  key, the voltage supply was disrupted. This prevented the data from being stored in the longterm EEPROM memory.

Solution: Repeat programming.

10. watch doc

CamCon deactivates all output within 1ms when an error occurs. This behavior can be used as an extreme error message. Program a cam over the whole range of a chosen output (0 to 360 degrees) (security cam). This output should be slaved into the emergency deactivation circuit. To be able to program a security cam over the whole range, you have to program 2 cams with the following parameters:

1. Cam 1: 0 degrees to 1 degree
2. Cam 2: 1 degree to 0 degrees

After the security cam has been programmed, the display shows the message "**no cam**" after the output number.

11. Technical data of the CamCon

LCD - text display	with 8 lines with 40 characters each, multi-languag (german, english and french)
LED - multi funktion display.....	for actual position display, Program No., speed, number of cams
Number of outputs	32 (optionally 64)
Status display of the outputs.....	one red LED beam display for each of the first 32 outputs
Number of programmable cams	up to 220 per program (total 1100)
Number of programs	128
Programming and optimizing of the cams	over the whole range of the engine
Cycle time, (switching speed)	1ms
Encoder - input	synchronous serial (SSI), gray coded, (optionally parallel data input
Encoder - type.....	AAG626 / AAG66107 Stegmann
Encoder - resolution.....	4096 * 4096 steps.
Zero point offset	electronic adjustment in the CamCon
Rotation direction of the encoder.....	is programmed at the CamCon
Cable length to encoder	400m
Data security/Storage	32K - EEPROM
Supply voltage	24V DC \pm 20 %
Encoder supply.....	24V DC via supply voltage of the CamCon
Current absorbtion.....	300mA without encoder and outputs
Output current	40mA, short circuit proof, permanent current up to 300mA (see chapter "The outputs")
Output voltage.....	24V DC, plus switching
Connectors for:	
Encoder	via plug block pins
Voltage supply.....	via plug block pins
Cam outputs.....	via flat band plug
Operating temperature.....	0°C to +55°C
Cover type for front cover	IP 65
Front cover dimensions	245mm x 192mm + (1,0 mm)
Cover (DIN 43700).....	263mm x 213mm x 42mm (WxHxD)
Attachment.....	a) 4 neck screws M2.5 \times 11 (supplied) b) 4 attachment clips (supplied)
PC connection	with DIGISOFT software package
Weight	about 1500g

12. Key word table

A-ERR	32
Adjustment of the board	13
Automatic display.....	31
Cam search.....	27
Commissioning	21
Complete deletion.....	22
Construction of a dual controller system	11
Construction of a tripple controller system	12
Deletion	28
Deletion of a program	29
Deletion of a programmed cam.....	28
Disruptions	32
Editing cams.....	27
Electrical connections.....	8
encoder	8
Example for cam programming	30
External program selection	8
I-ERR	32
Input of cams	27
Installation instructions	7
Introduction	5
keyboard.....	19
Language.....	23
LCD.....	18
LED display bar	18
main menu.....	21
millenium	2
Multi axis systems.....	11
Opening the multi axis device	14
Optimizing cams	28
Ordering the new axis	13
Outline of the user terminal.....	17
Output selection.....	26
outputs.....	8
Pin allocation in a multi axis system.....	15
pin allocation of the single axis	10
Position display.....	18
Priciple of function of a cam controller	6
Principle of function.....	6
Program selection.....	26; 31
Programming.....	21
programming cams	26
Real encoder resolution.....	24
rotation direction.....	24
serial interface.....	8
seven-segment display.....	18
Speed display.....	18
Speed factor	25
system constants.....	23
TEACH IN.....	28
Technichal data	34
Upgrading multi axis	13
watch doc	33
Zero point	24